

01 PLANTA  
ESCALA 1:25

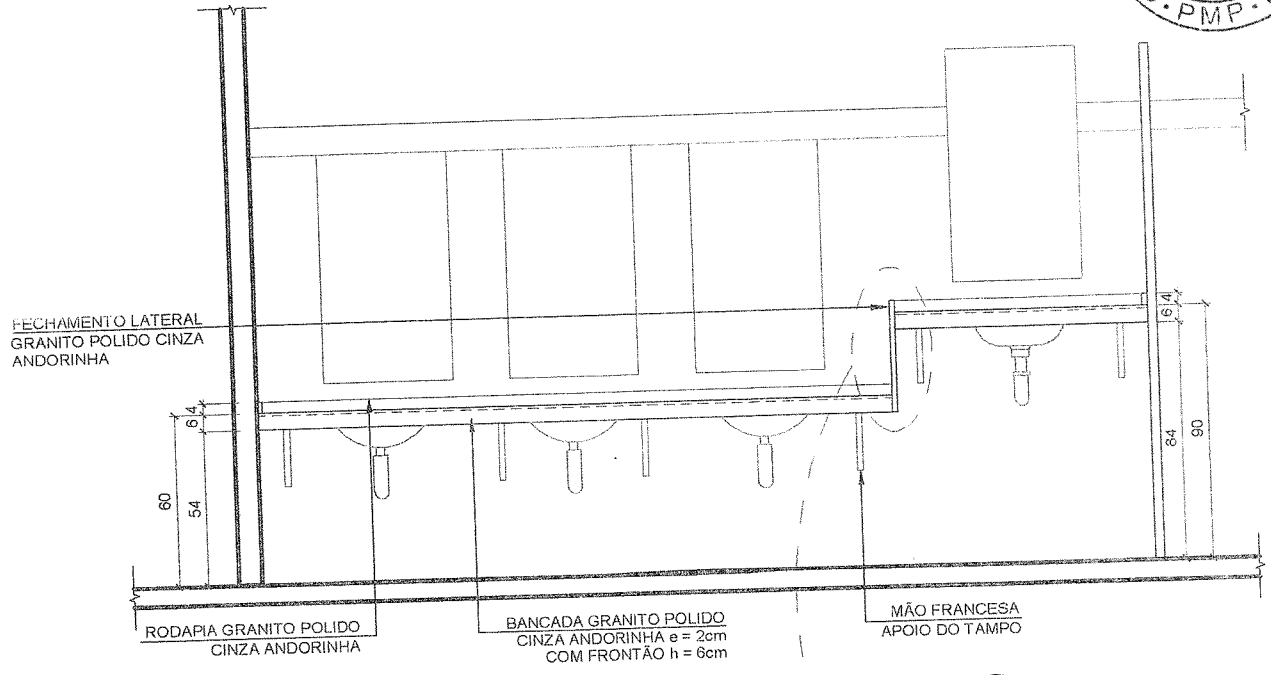

02 ELEVAÇÃO  
ESCALA 1:25

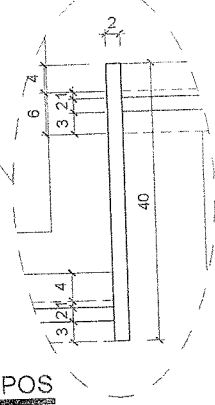

03 DETALHE TAMPOS  
ESCALA 1:10

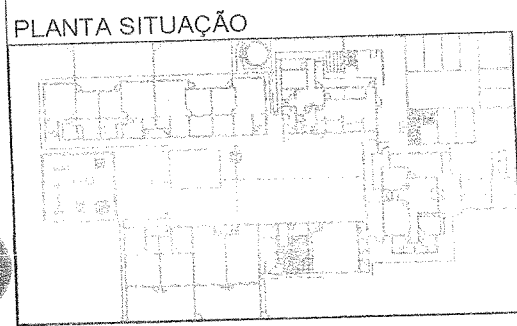

CRECHE TIPO B  
DETALHE BANCADA B07  
BL. MULTIUSO - SANIT. INF. FEM.

REV. 06  
15/43



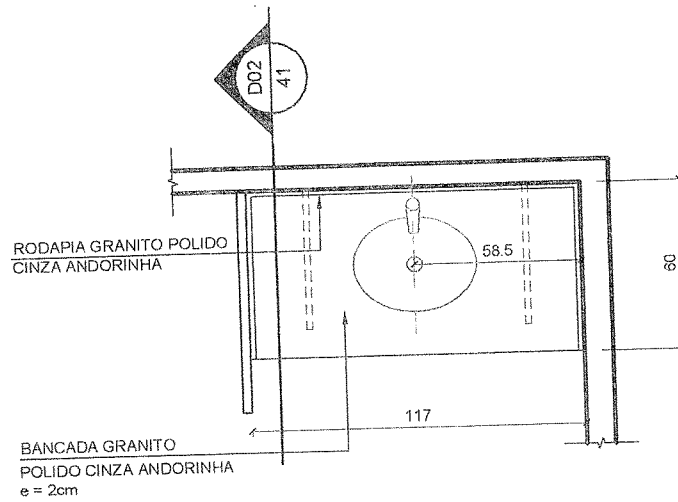
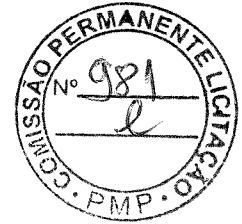
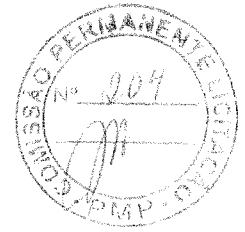

01 PLANTA  
ESCALA 1:25

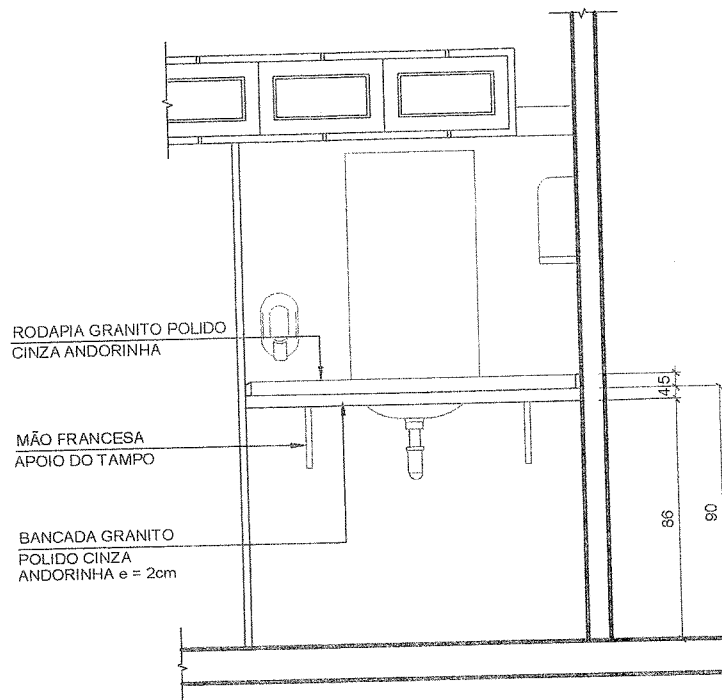

02 ELEVÇÃO  
ESCALA 1:25

PLANTA SITUAÇÃO

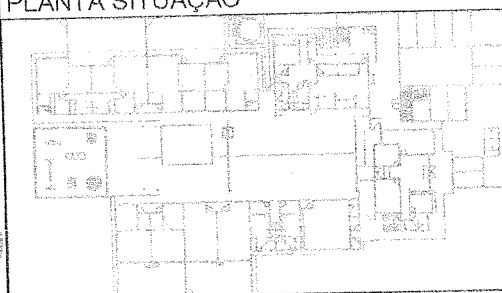

CRECHE TIPO B  
DETALHE BANCADA B08  
BLOCO ADMINISTR. - SANIT.FEM.

REV. 06

16/43

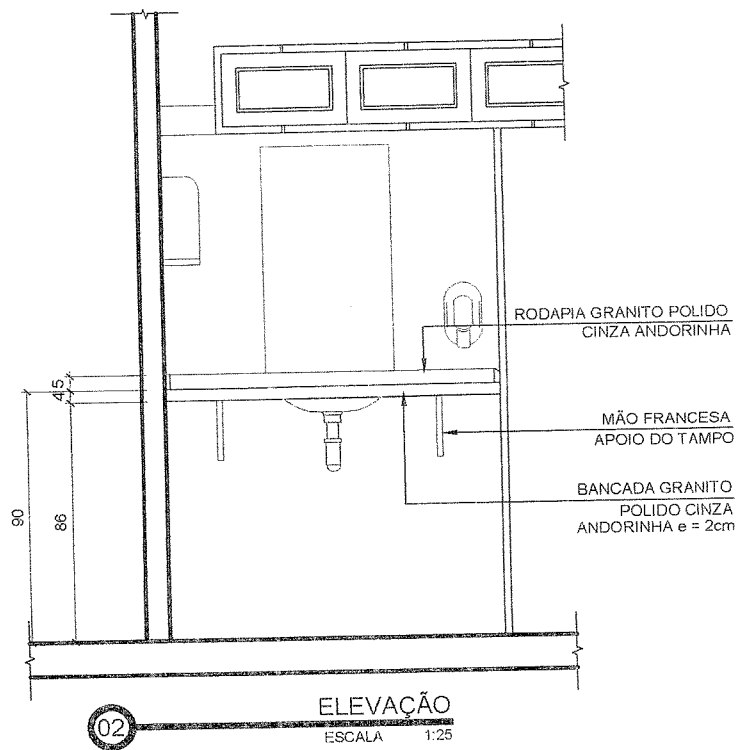
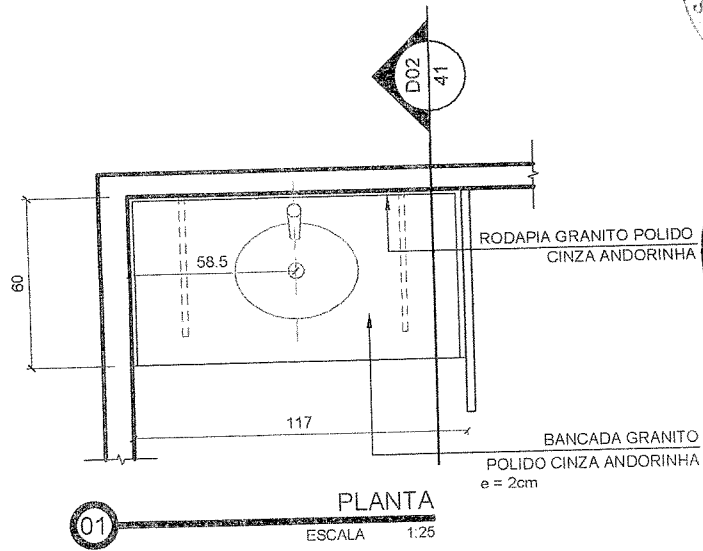
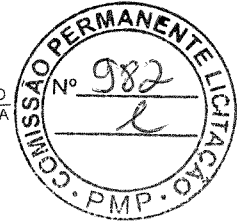

PLANTA SITUAÇÃO

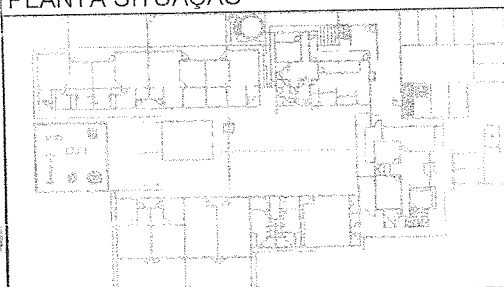

CRECHE TIPO B  
DETALHE BANCADA B08  
BLOCO ADMINISTR. - SANIT.MASC.

REV. 06

17/43

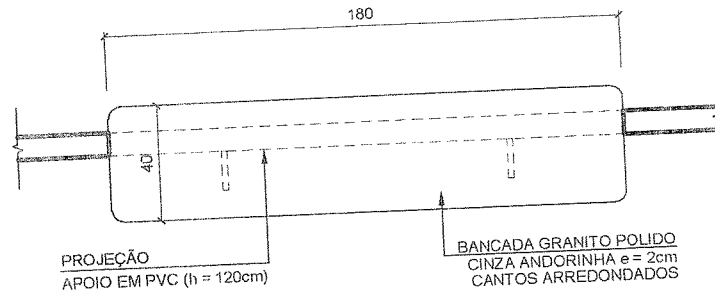
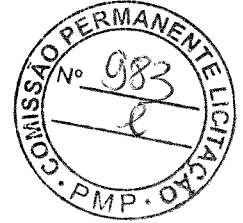

01 PLANTA  
ESCALA 1:25

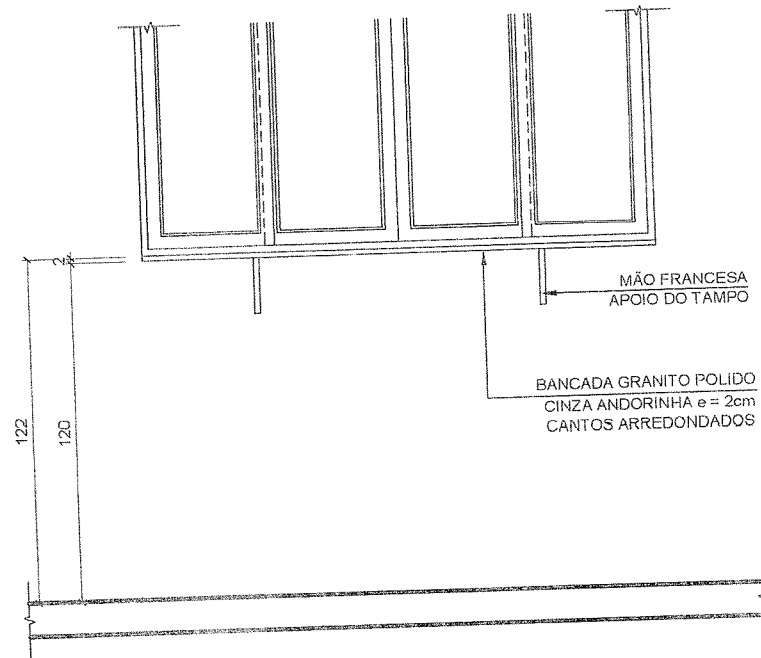

02 ELEVAÇÃO  
ESCALA 1:25

PLANTA SITUAÇÃO

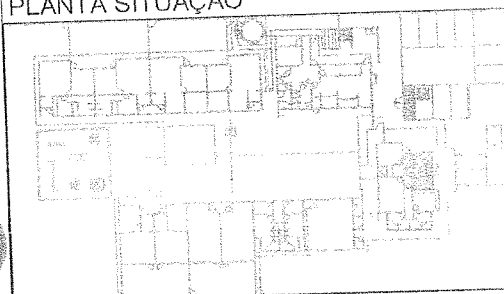

CRECHE TIPO B  
DETALHE BANCADA B09  
BLOCO ADMINISTR. - RECEPÇÃO

REV. 06

18/43



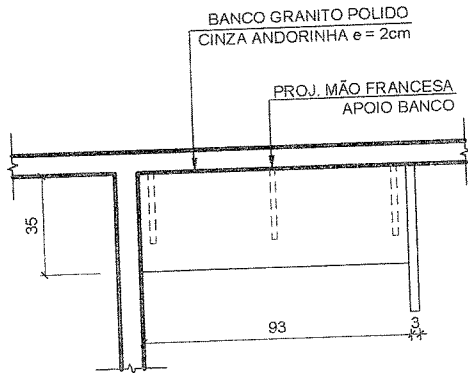

01 B21 - PLANTA  
ESCALA 1:25

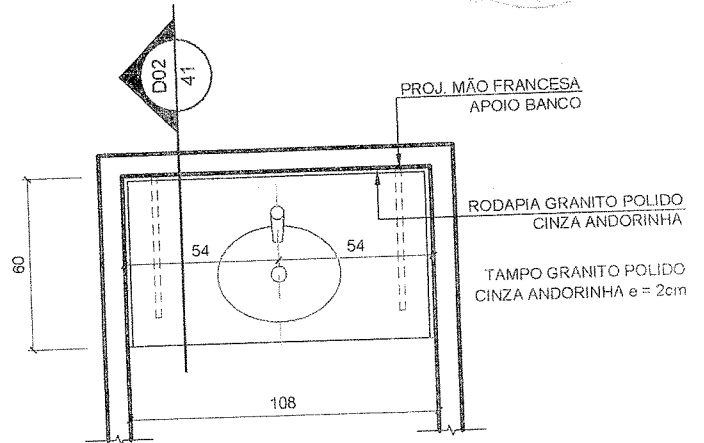

02 B10 - PLANTA  
ESCALA 1:25

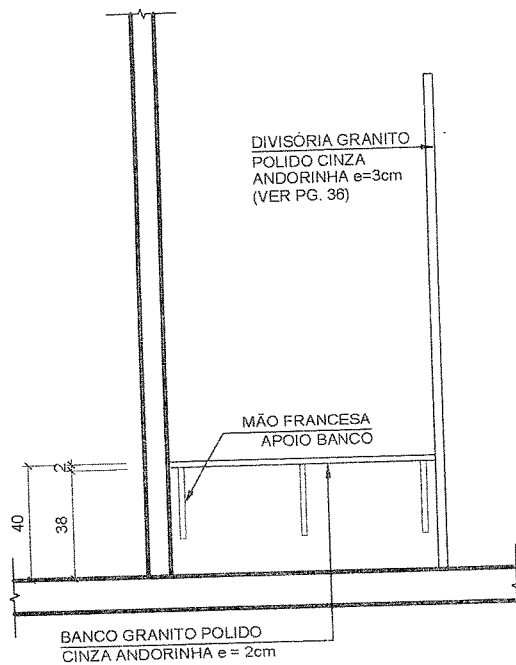

03 B21 - ELEVÇÃO  
ESCALA 1:25

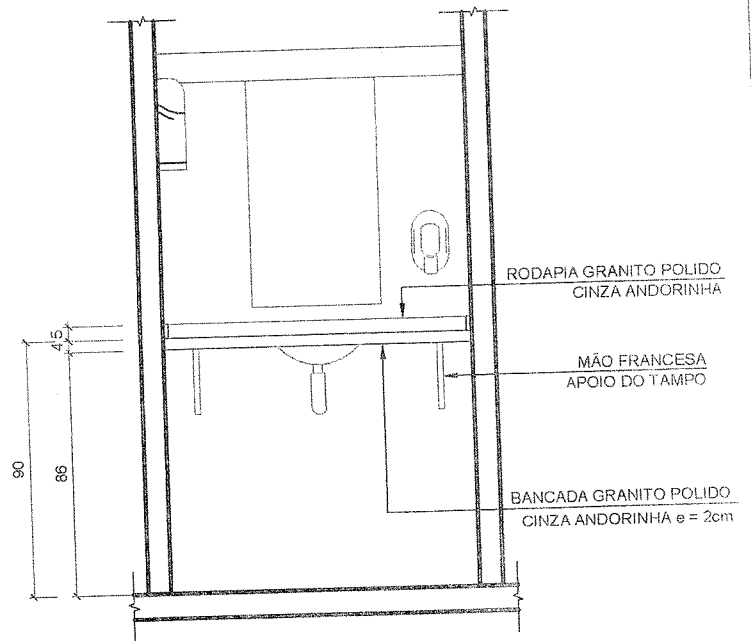

04 B10 - ELEVÇÃO  
ESCALA 1:25

PLANTA SITUAÇÃO

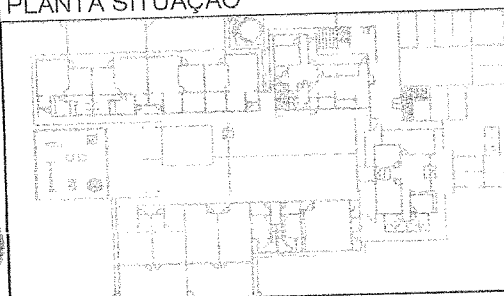

CRECHE TIPO B  
DET. BANCADA B10 E BANCO B21  
VESTIÁRIO MASCULINO

REV. 06

19/43



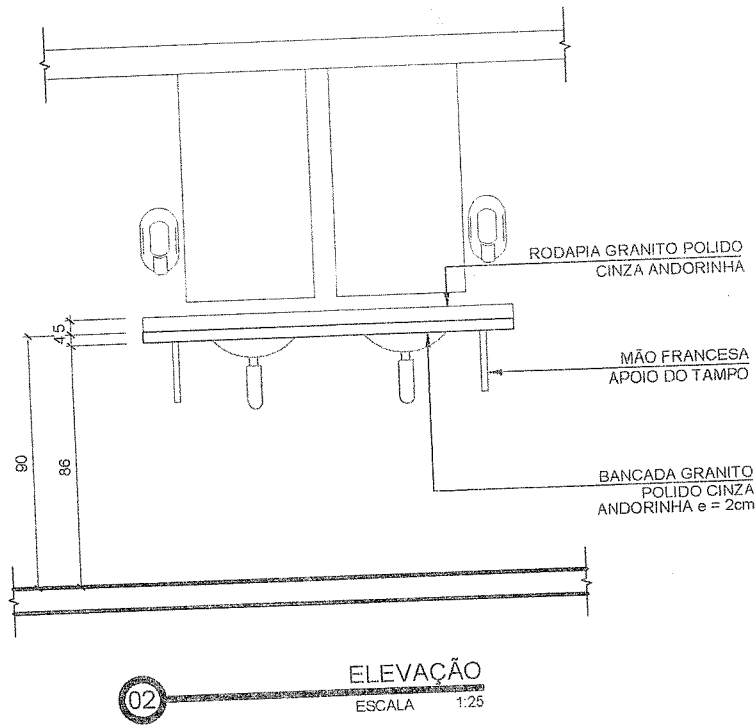
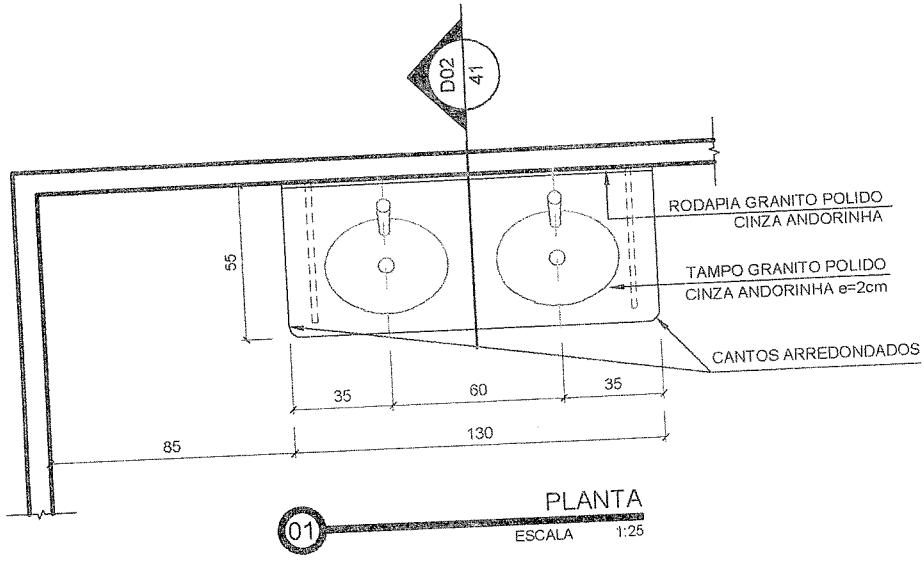
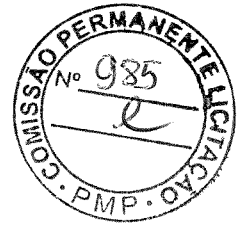
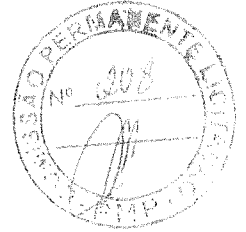

PLANTA SITUAÇÃO

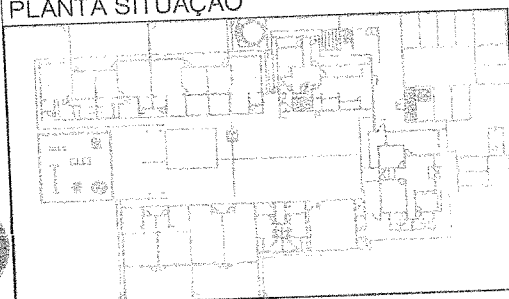

CRECHE TIPO B  
DETALHE BANCADA B11  
VESTIÁRIO FEMININO

REV. 06

20/43



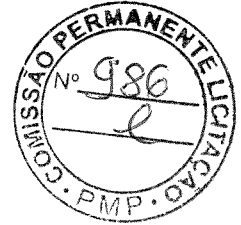

RODAPIA GRANITO POLIDO  
CINZA ANDORINHA/h=5cm

TAMPO GRANITO POLIDO  
CINZA ANDORINHA e = 2cm

BORDA LIMITE ÁREA MOLHADA  
GRANITO POLIDO CINZA ANDORINHA e = 2cm

PROJEÇÃO MURETA PVC  
h = 90cm

01

PLANTA

ESCALA 1:25

RODAPIA GRANITO POLIDO  
CINZA ANDORINHA/h=5cm

CUBA RETANGULAR AÇO INOX  
34x40x17cm C/ VALVULA

APOIO EM PVC  
(h = 90cm c = 60cm)

02

ELEVAÇÃO

ESCALA 1:25

PLANTA SITUAÇÃO

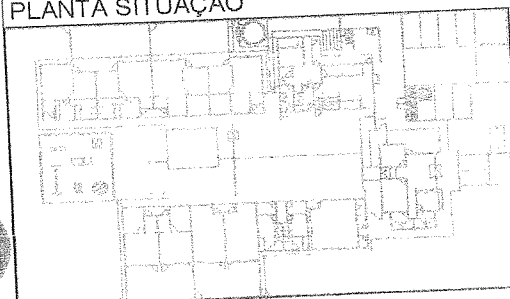

CRECHE TIPO B  
DETALHE BANCADA B12  
LACTÁRIO

REV. 06

21/43



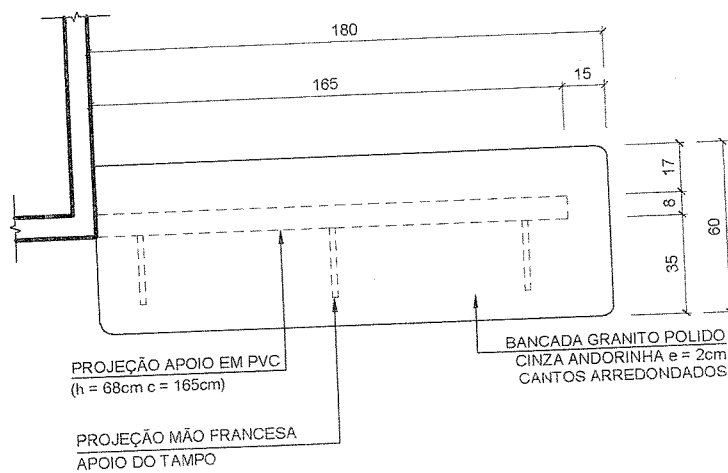
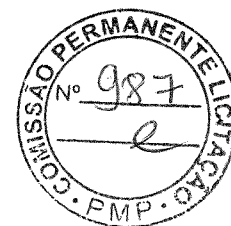
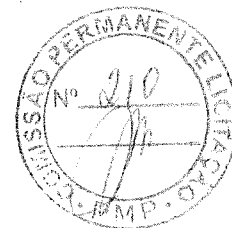

01 PLANTA  
ESCALA 1:25

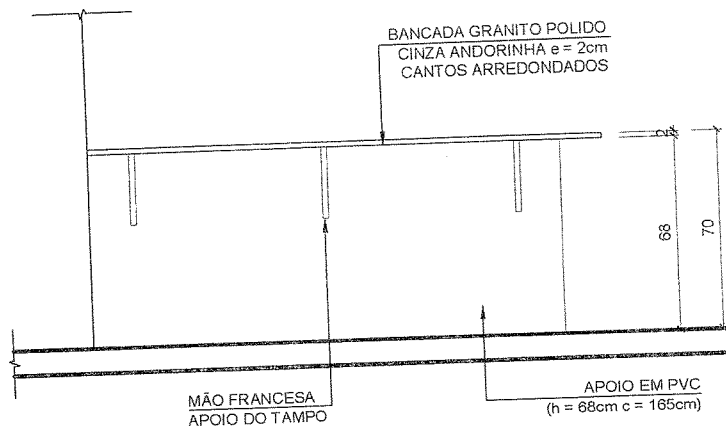

02 ELEVACÃO  
ESCALA 1:25

PLANTA SITUAÇÃO

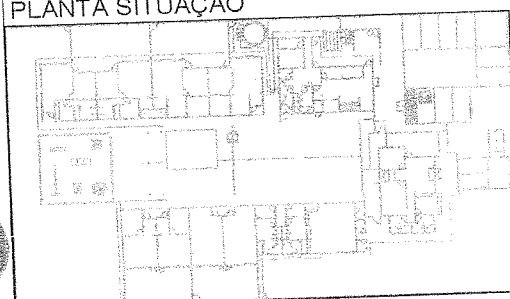

CRECHE TIPO B  
DETALHE BANCADA B13  
BUFFET

REV. 06

22/43





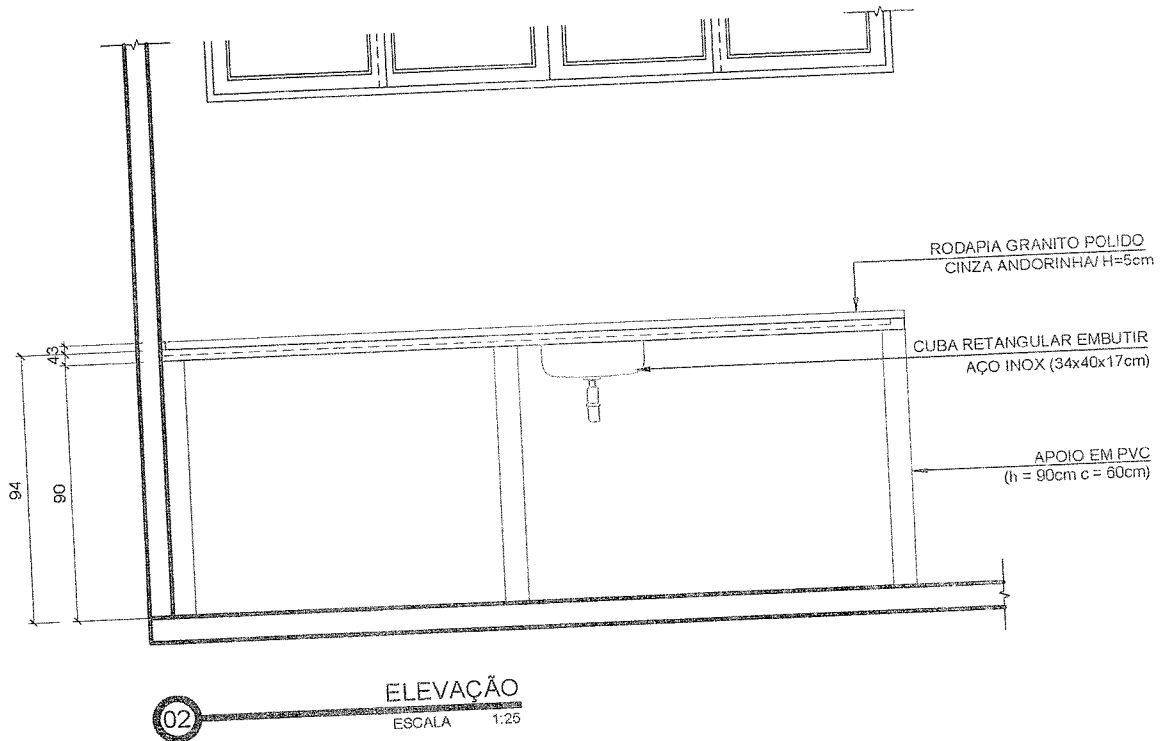
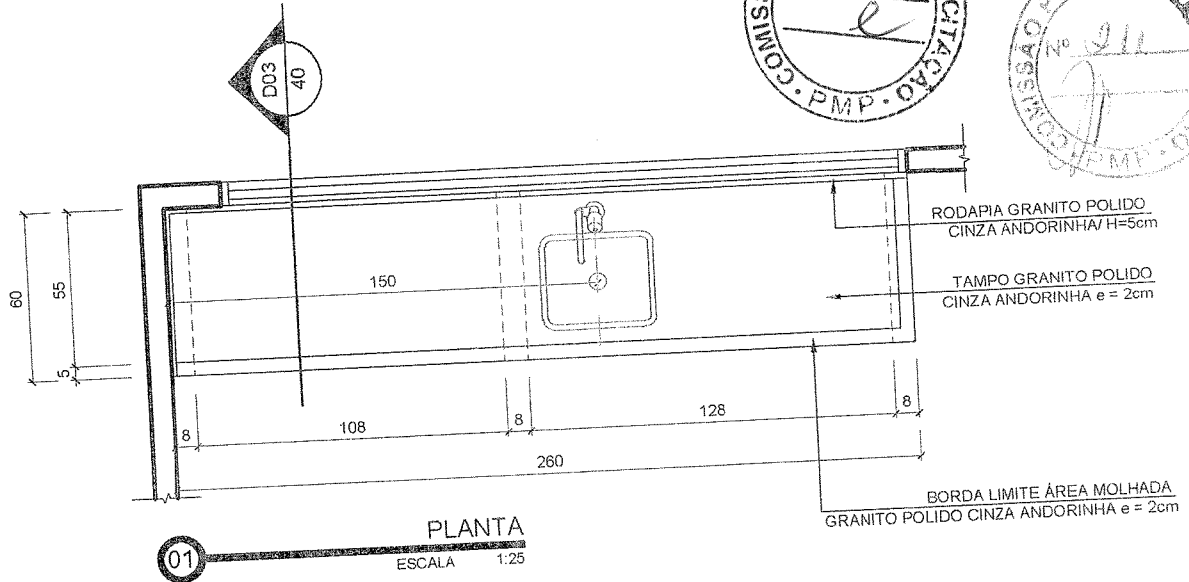
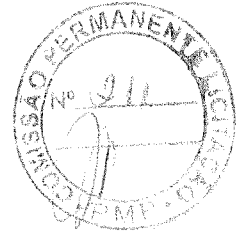
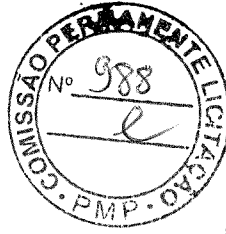

PLANTA SITUAÇÃO

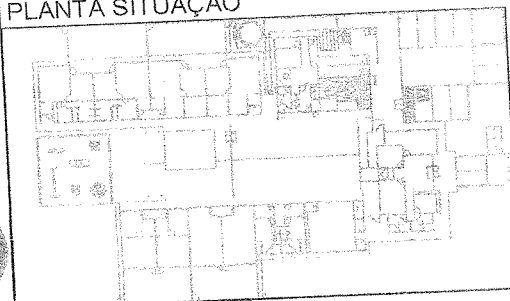

CRECHE TIPO B  
DETALHE BANCADA B14-A  
COZINHA

REV. 06

23/43



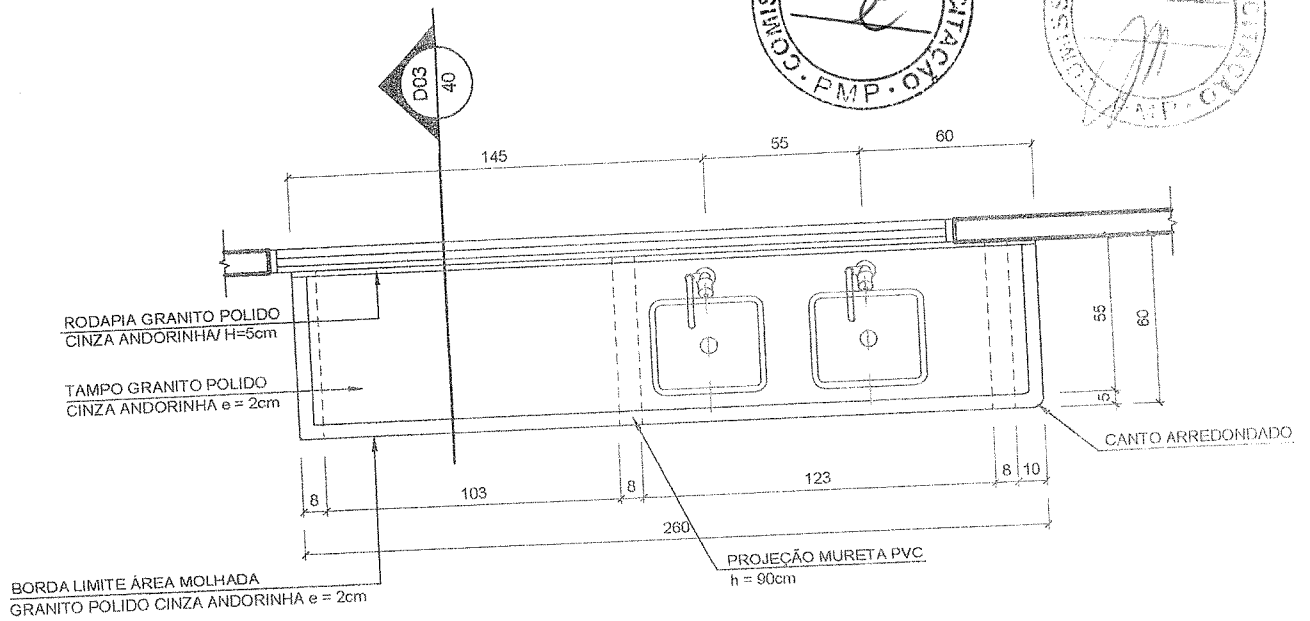
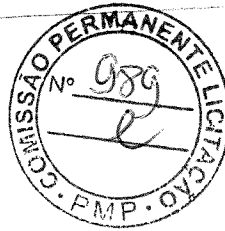

01 PLANTA  
ESCALA 1:25

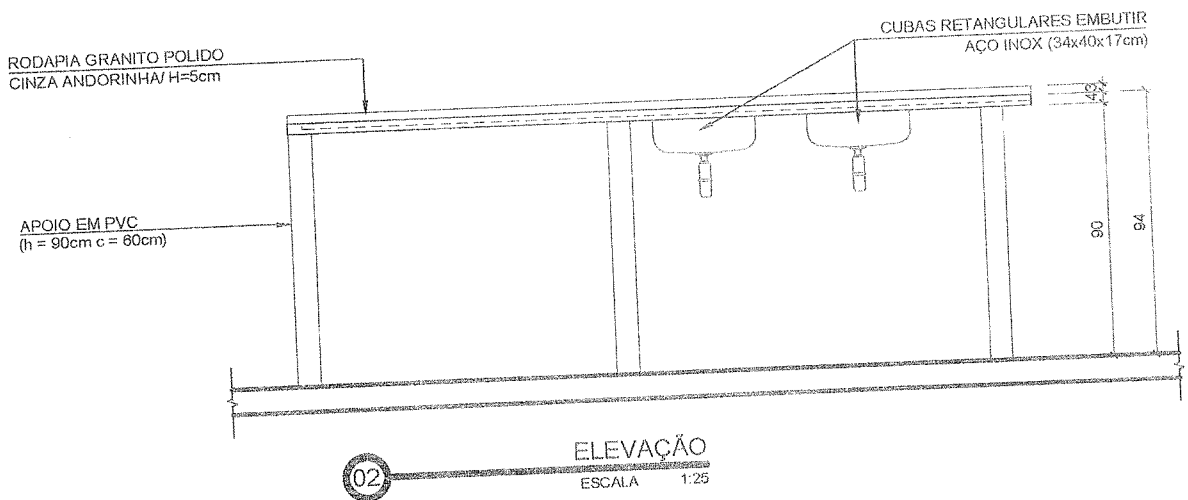
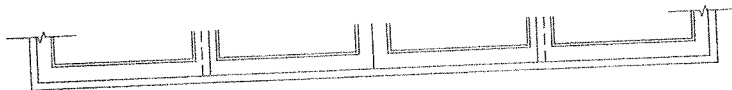

PLANTA SITUAÇÃO

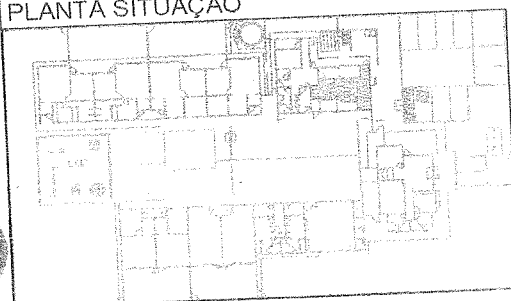

CRECHE TIPO B  
DETALHE BANCADA B14-B  
COZINHA

REV. 06

24/43



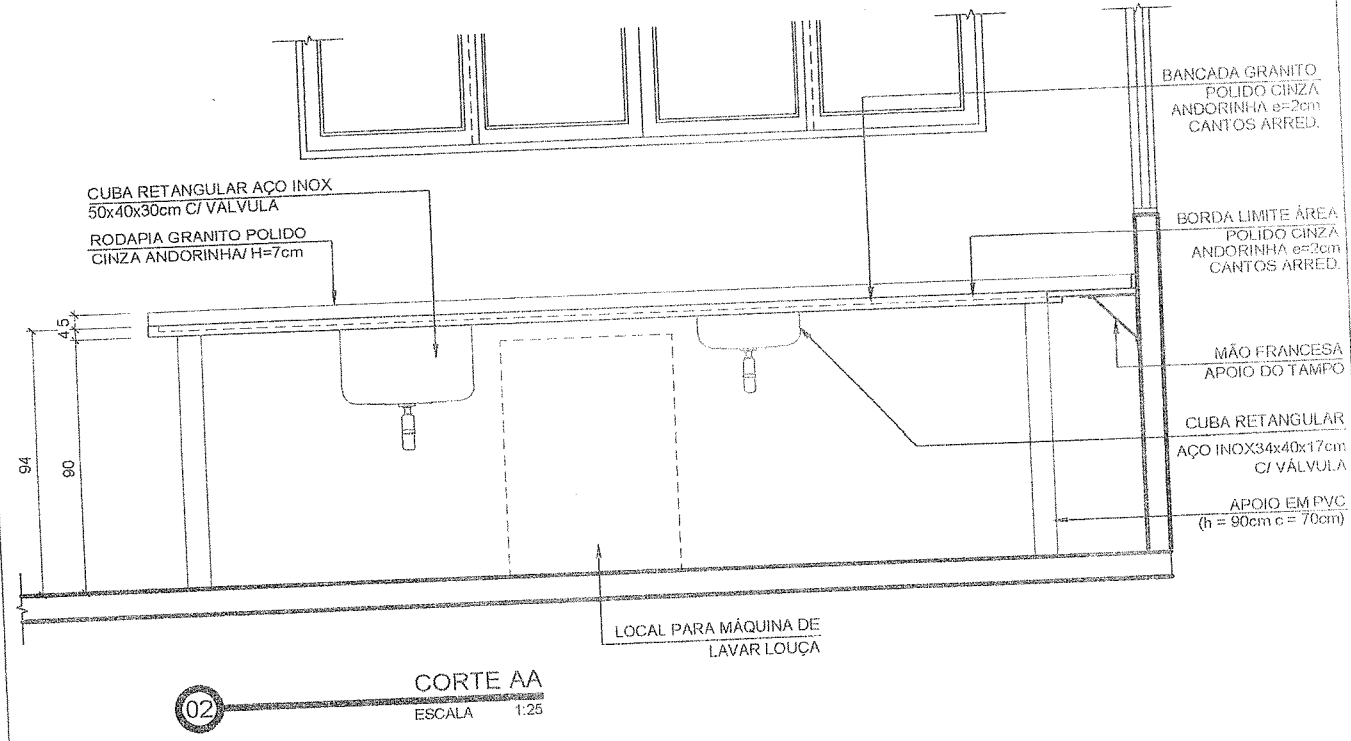
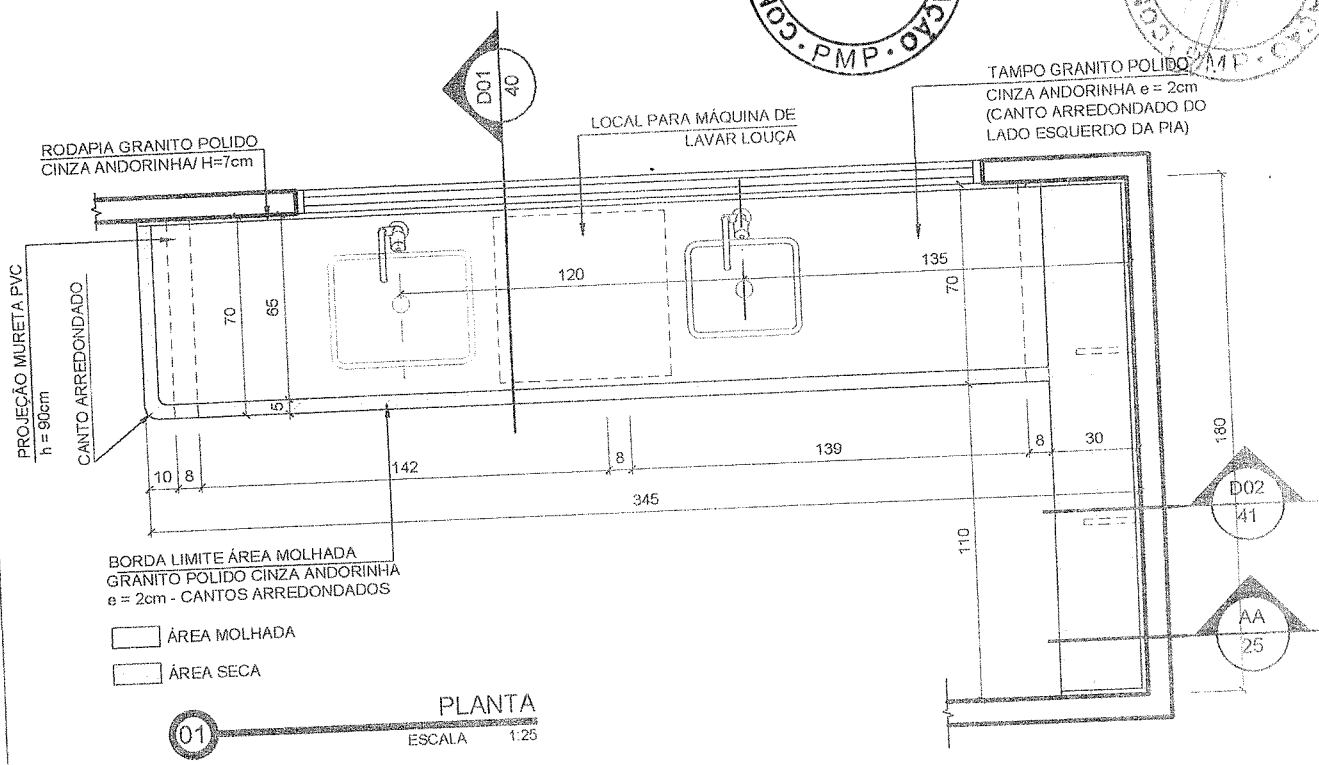
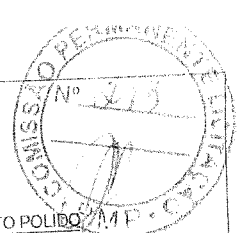
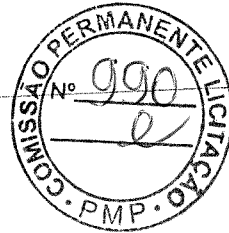

CRECHE TIPO B  
DETALHE BANCADA B15  
COZINHA

REV. 06  
25/43

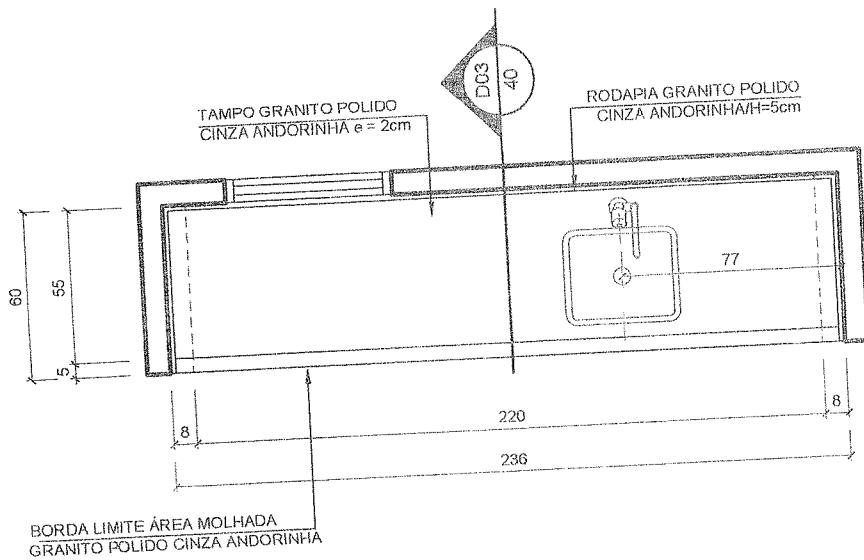
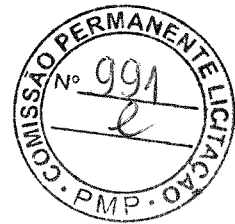
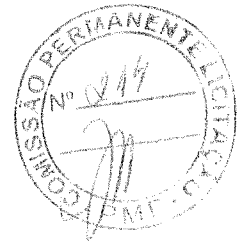

01 PLANTA  
ESCALA 1:25

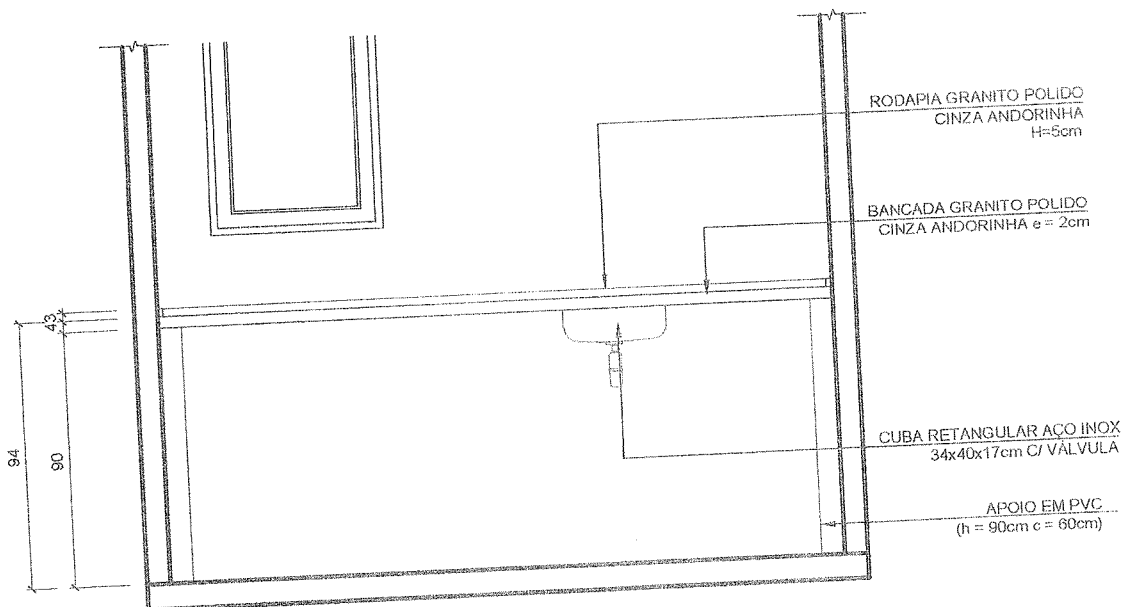

02 ELEVÇÃO  
ESCALA 1:25

PLANTA SITUAÇÃO

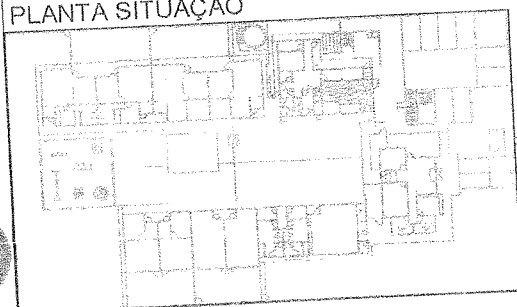

CRECHE TIPO B  
DETALHE BANCADA B16  
COZINHA

REV. 06

26/43



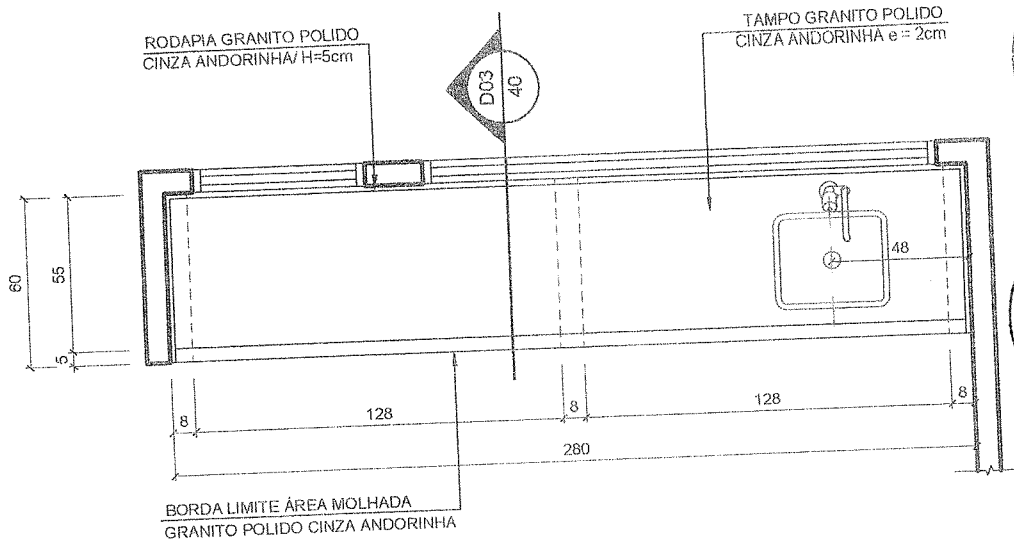

01 PLANTA  
ESCALA 1:25

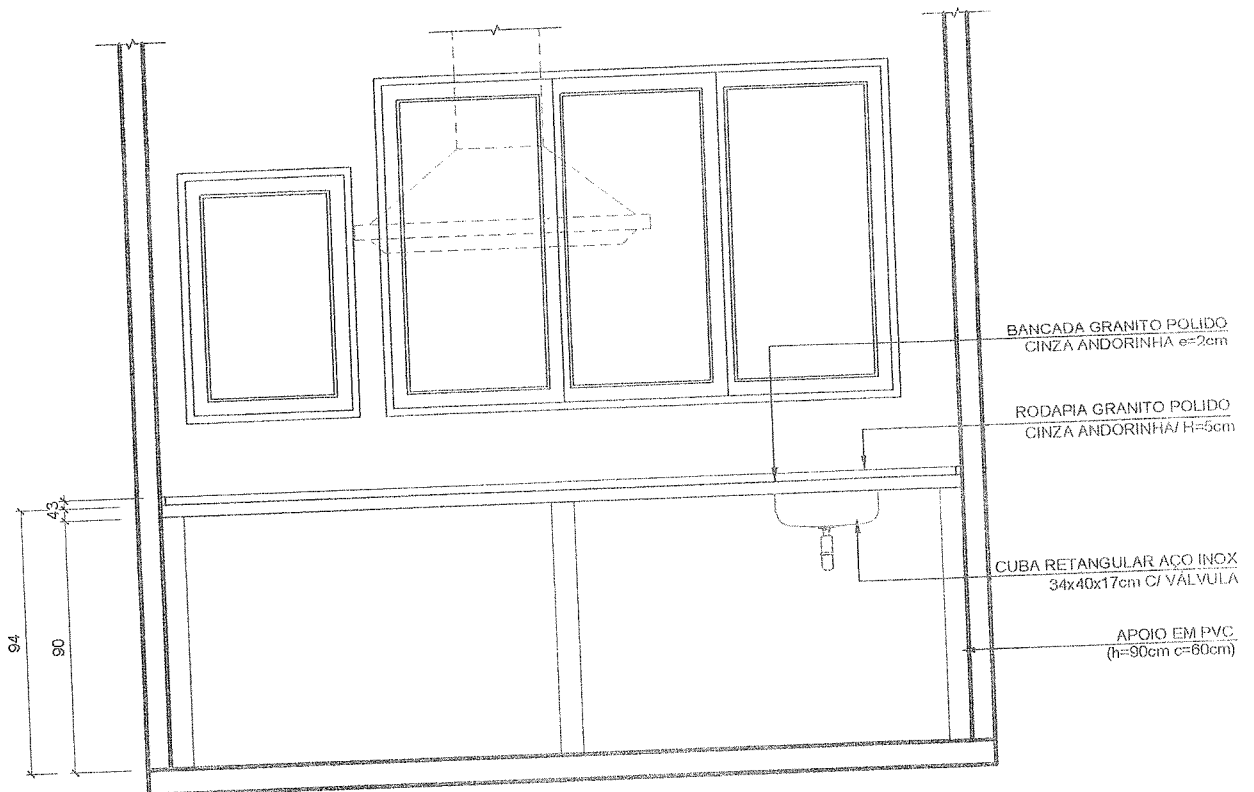

02 ELEVACÃO  
ESCALA 1:25

PLANTA SITUAÇÃO

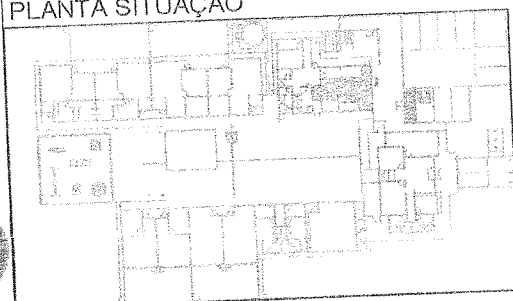

CRECHE TIPO B  
DETALHE BANCADA B17  
COZINHA

REV. 06

27/43

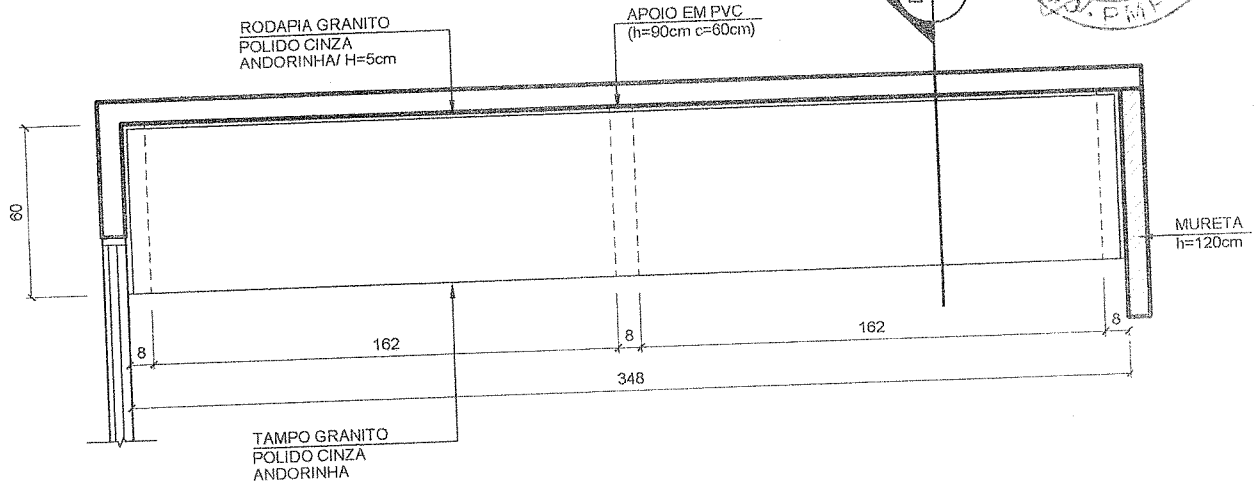
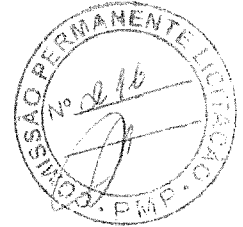
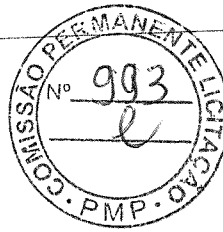

01 PLANTA  
ESCALA 1:25

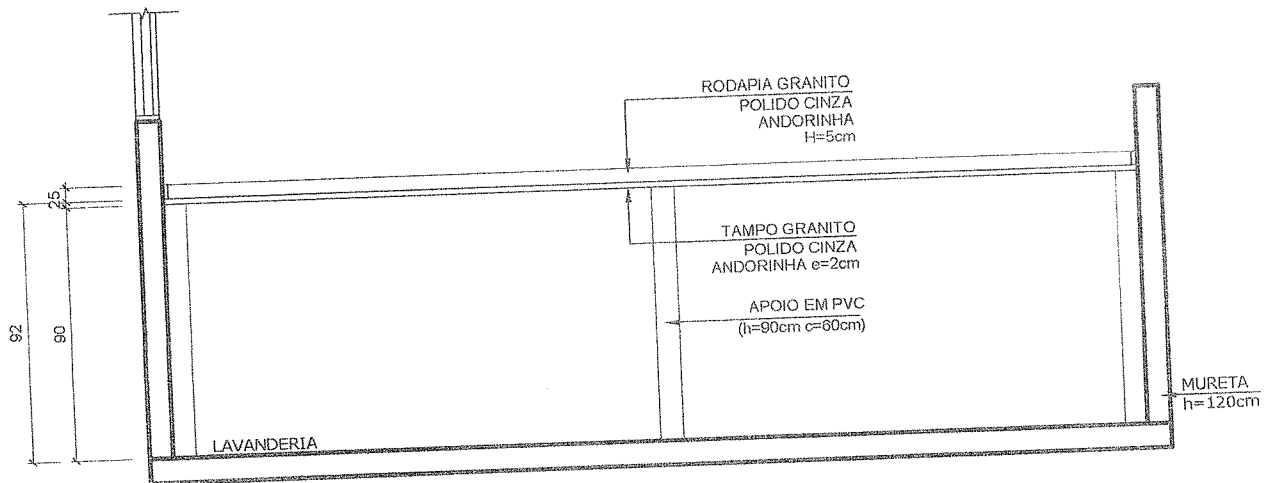

02 ELEVACÃO  
ESCALA 1:25

PLANTA SITUAÇÃO

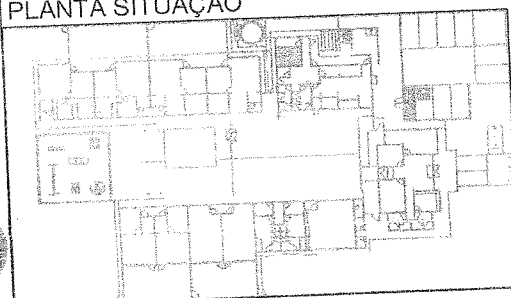

CRECHE TIPO B  
DETALHE BANCADA B18  
LAVANDERIA

REV. 06

28/43

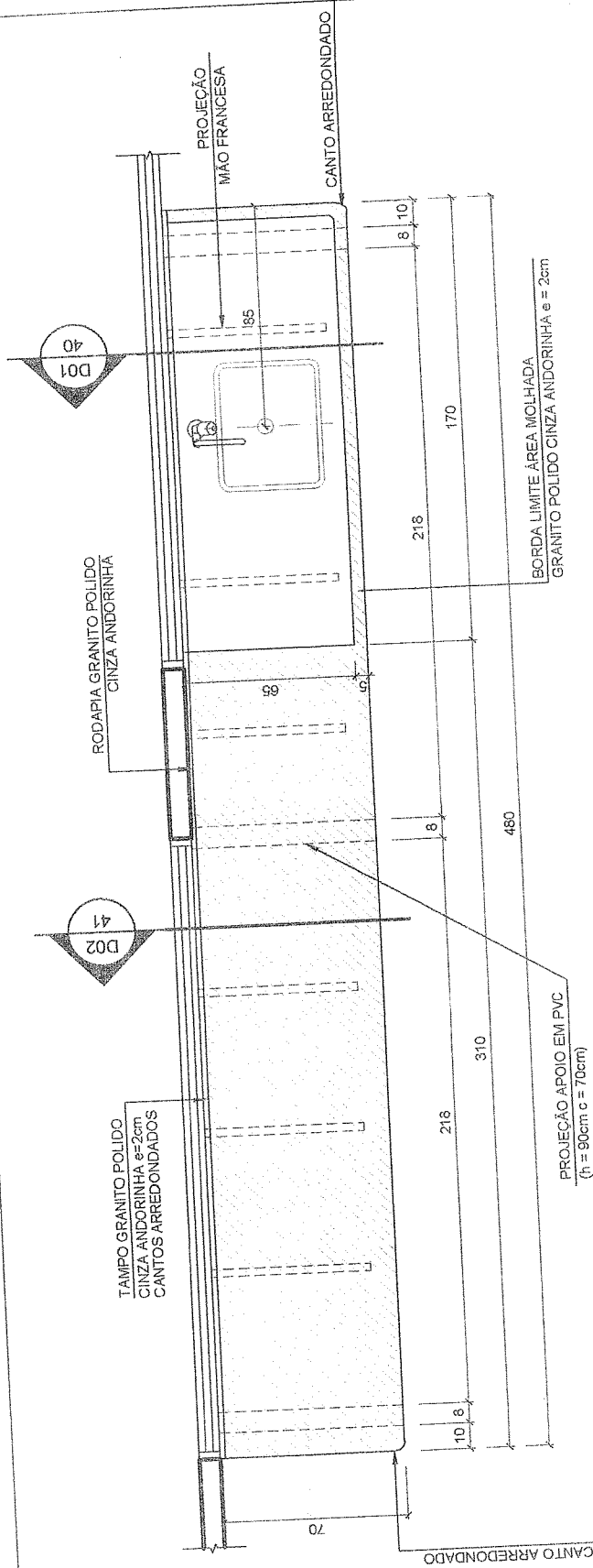

PLANTA SITUAÇÃO

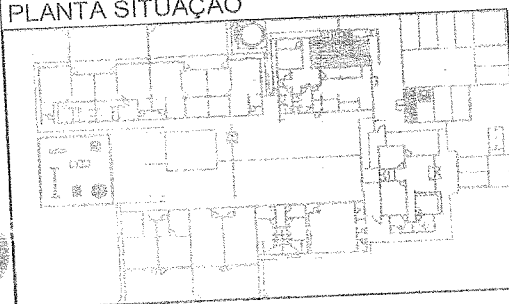

- ÁREA MOLHADA
- ÁREA SECA

01  
PLANTA  
ESCALA 1:25

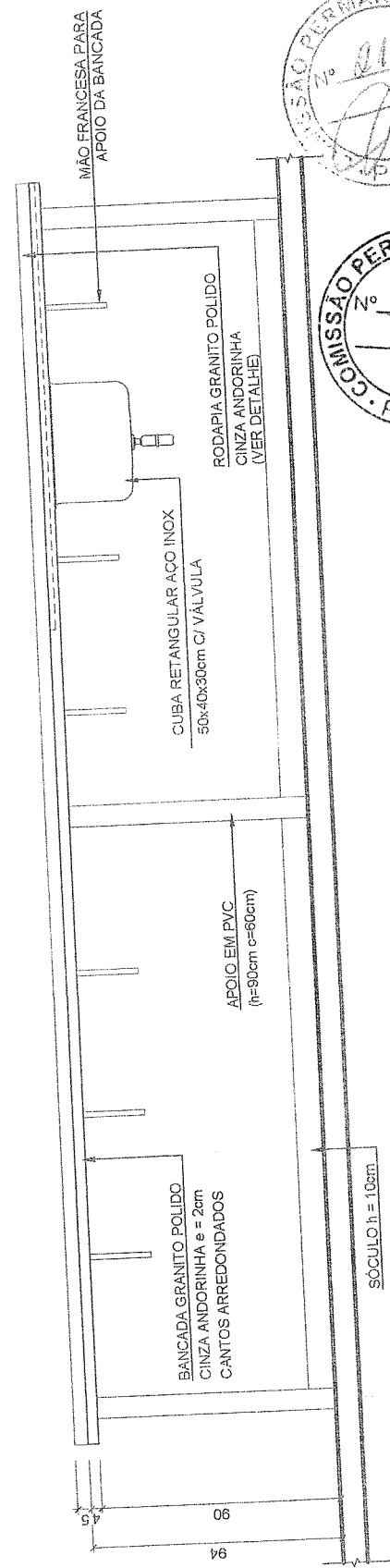

02  
ELEVACÃO  
ESCALA 1:25

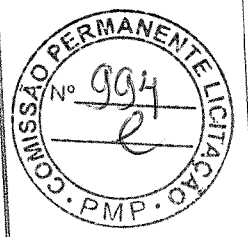
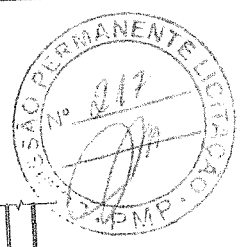

**CRECHE TIPO B**  
**DETALHE BANCADA B19**  
**ÁREA DE SERVIÇO**

REV. 06  
**29/43**

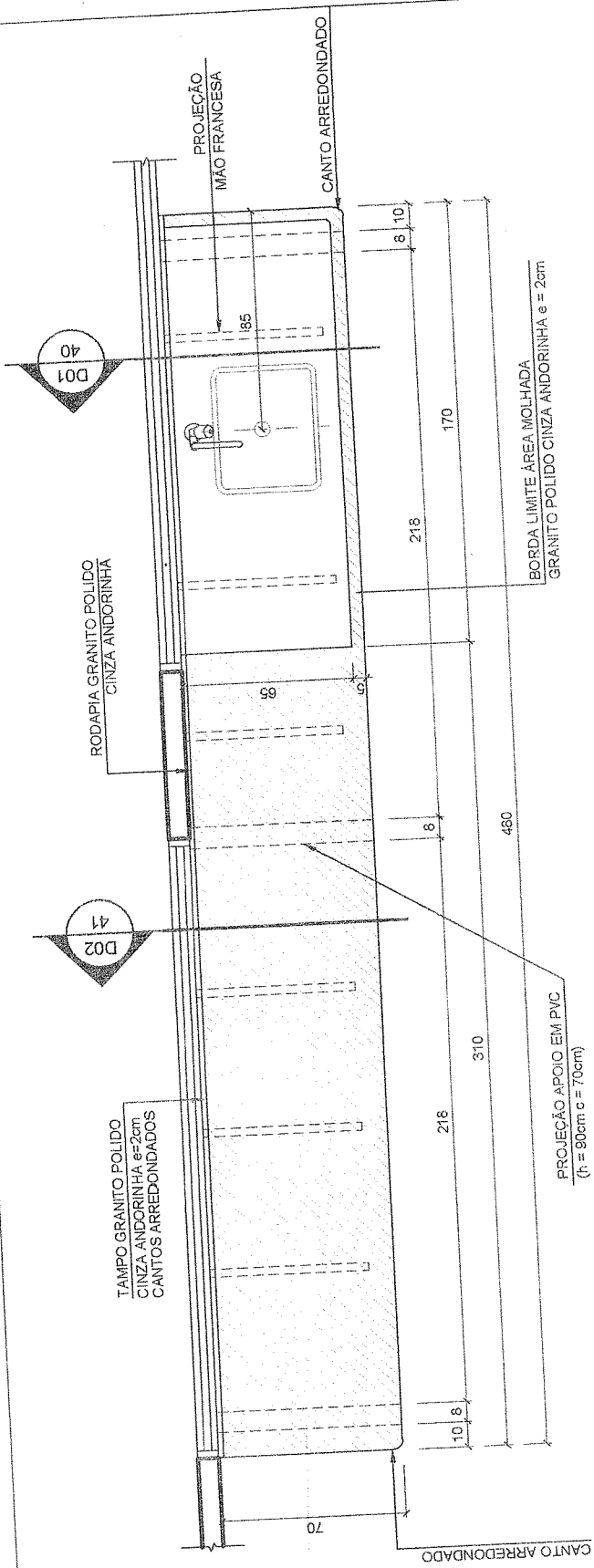
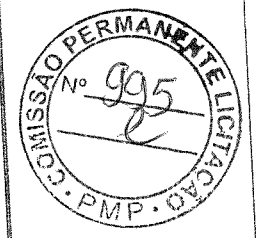
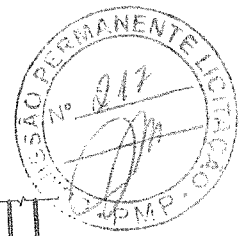

01  
PLANTA  
ESCALA 1:25

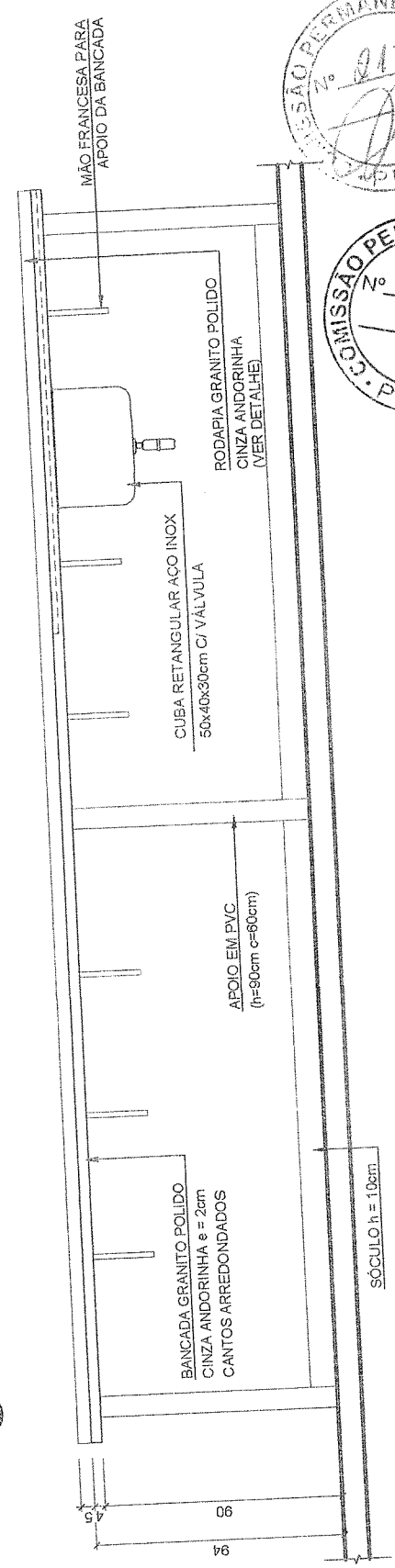

02  
ELEVACÃO  
ESCALA 1:25

PLANTA SITUAÇÃO

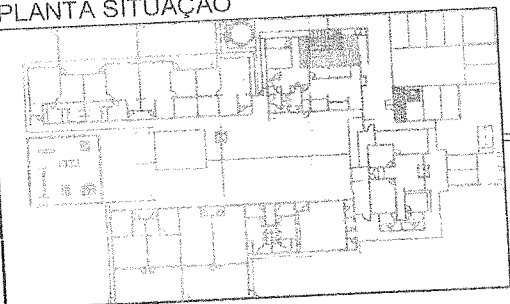

- ÁREA MOLHADA
- ÁREA SECA

# CRECHE TIPO B DETALHE BANCADA B19 ÁREA DE SERVIÇO

REV. 06  
29/43





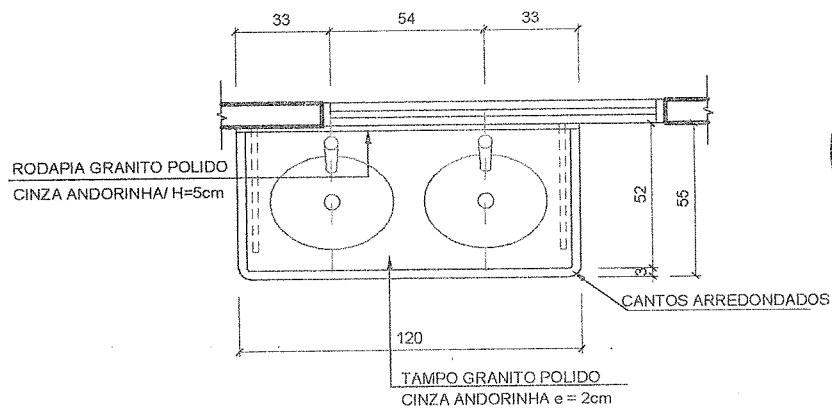
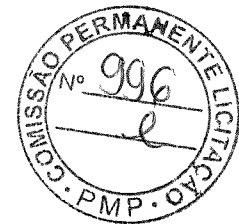
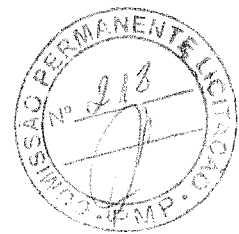

01 PLANTA  
ESCALA 1:25

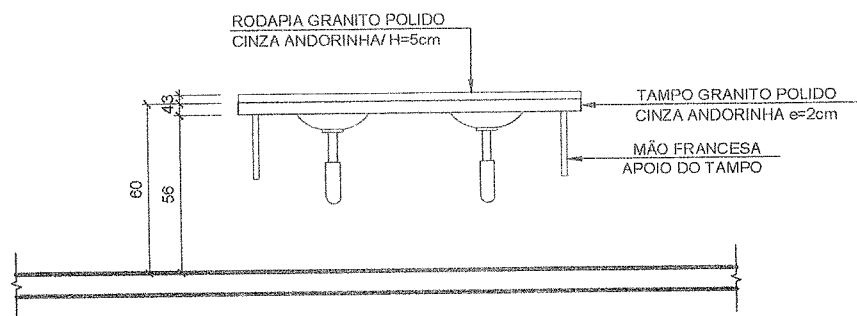
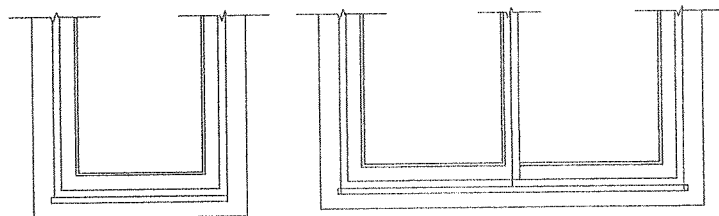

02 ELEVAÇÃO  
ESCALA 1:25

PLANTA SITUAÇÃO

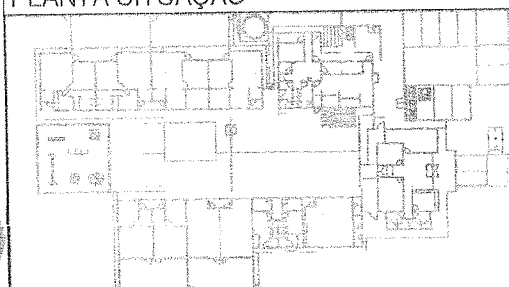

CRECHE TIPO B  
DETALHE BANCADA B20  
PÁTIO

REV. 06

30/43

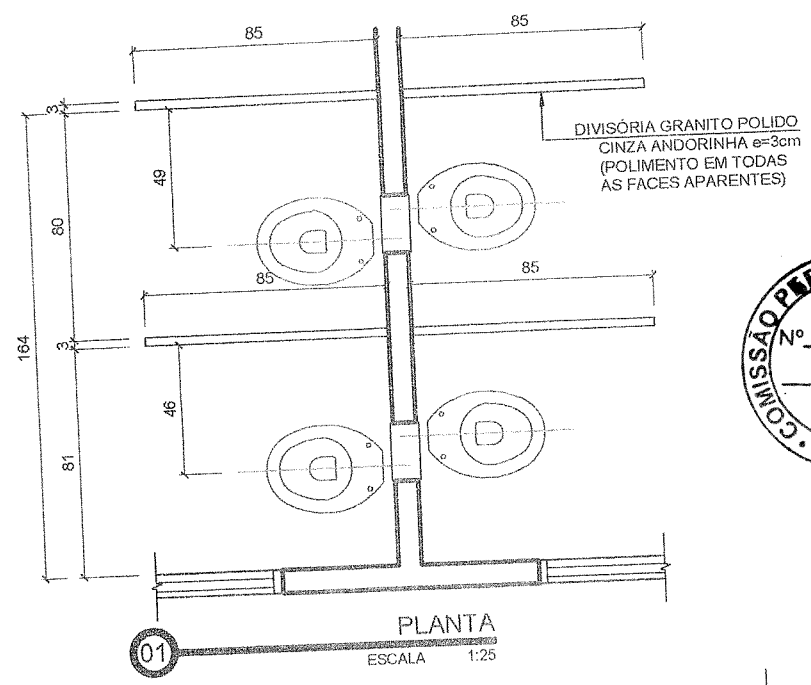
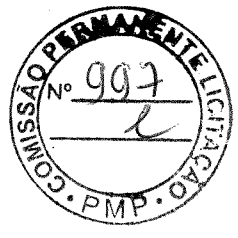
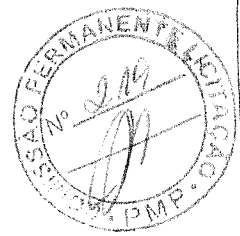

DIVISÓRIA GRANITO POLIDO  
CINZA ANDORINHA e=3cm  
(POLIMENTO EM TODAS  
AS FACES APARENTES)

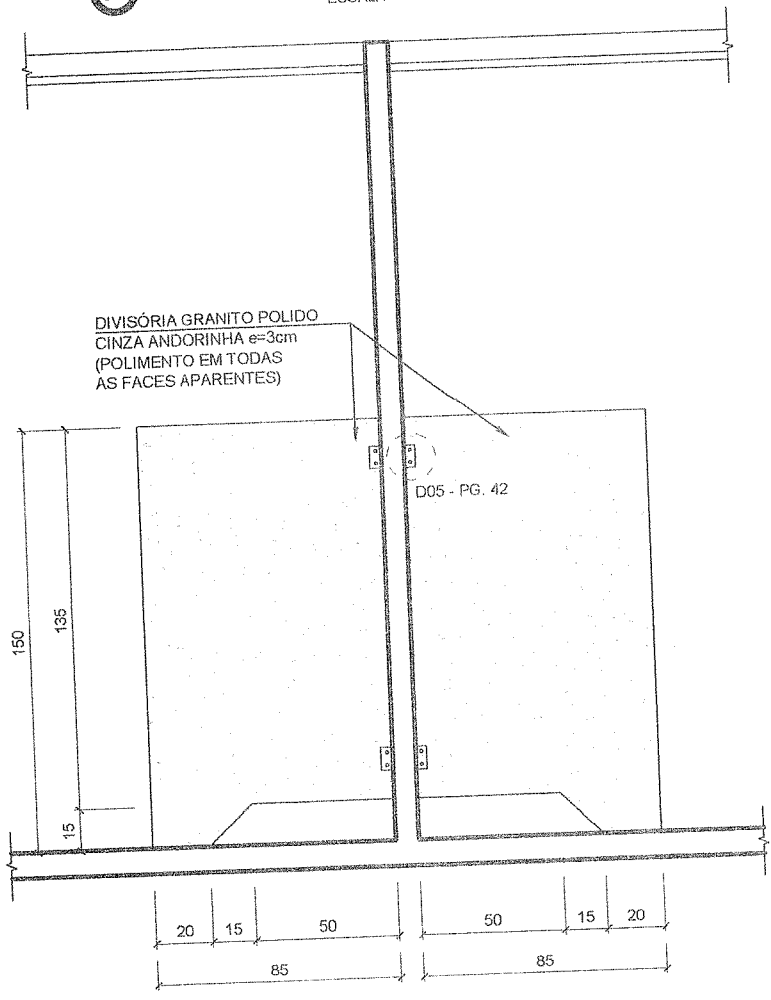

PLANTA SITUAÇÃO

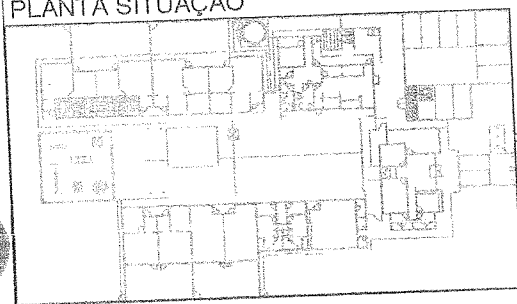

ELEVACÃO  
ESCALA 1:25

CRECHE TIPO B  
DETALHE DIVISÓRIA DV3-A  
SANIT. CRECHE II - BL. PEDAG. 1

REV. 06  
31/43



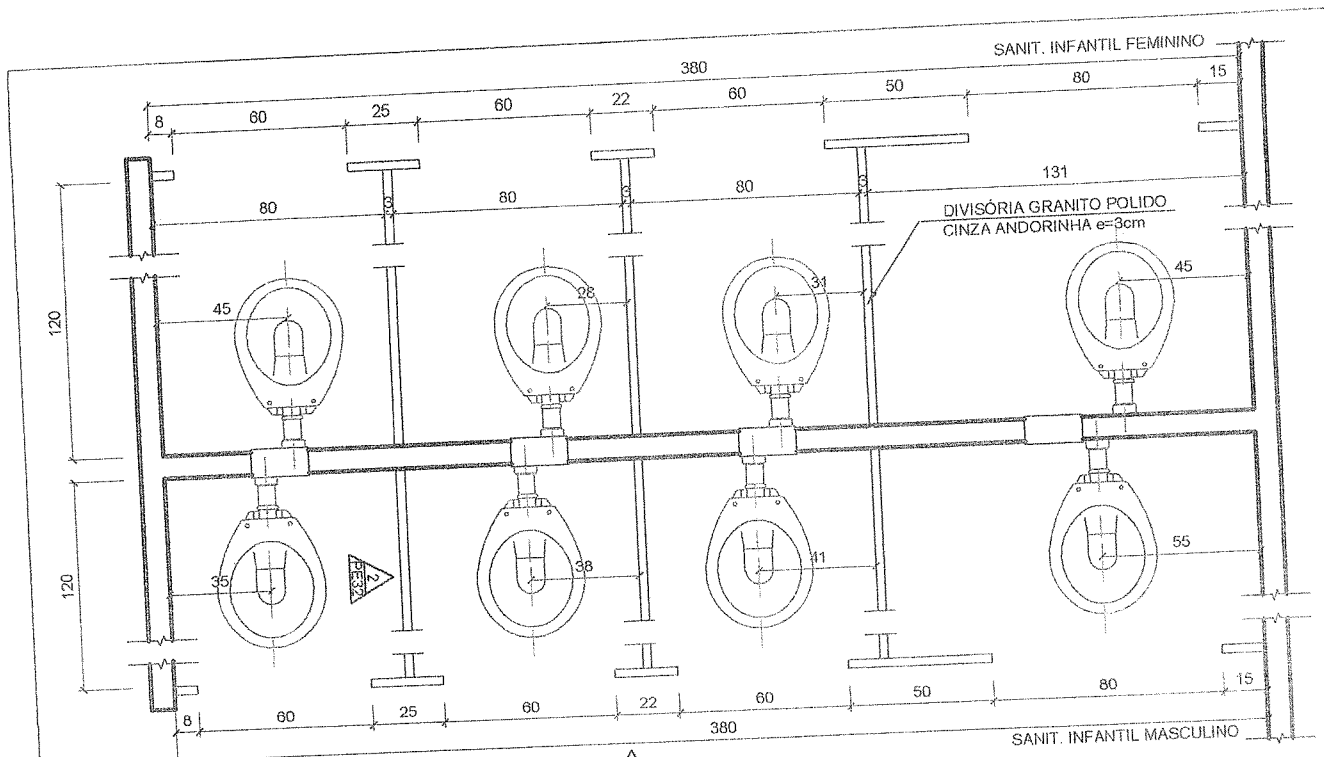

01 PLANTA  
ESCALA 1:25

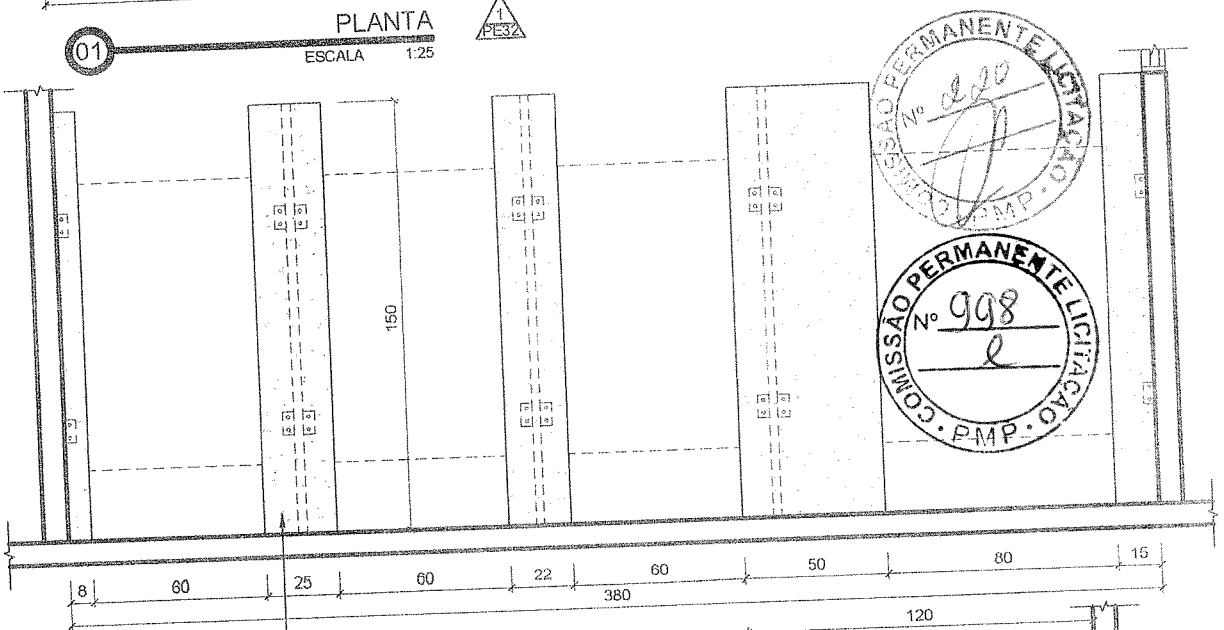

02 ELEVACÃO 1  
ESCALA 1:25

DIVISÓRIA GRANITO POLIDO  
CINZA ANDORINHA e=3cm  
(POLIMENTO EM TODAS  
AS FACES APARENTES)

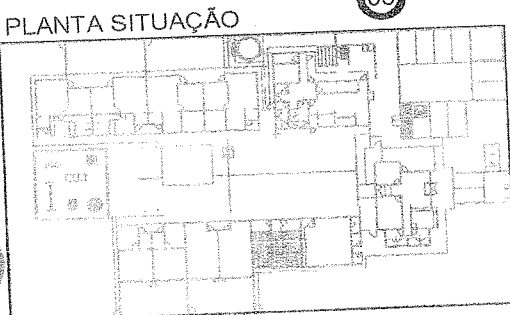

03 ELEVACÃO 2  
ESCALA 1:25

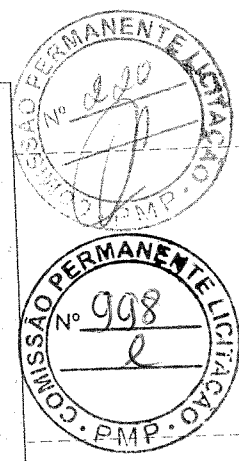
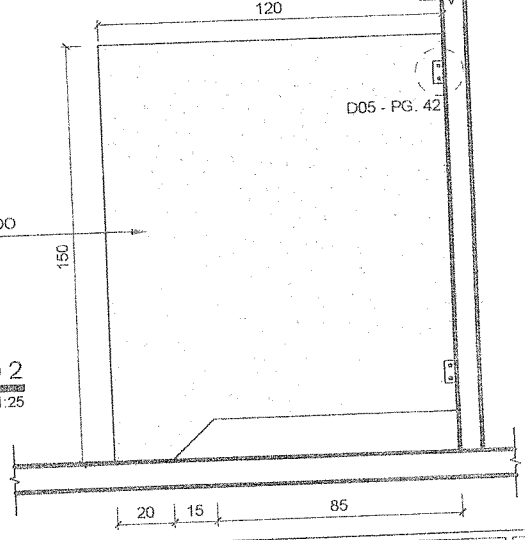

CRECHE TIPO B  
DETALHE DIVISÓRIA DV3-B  
SANIT. INFANTIL - BL. MULTIUSO

REV. 06  
32/43

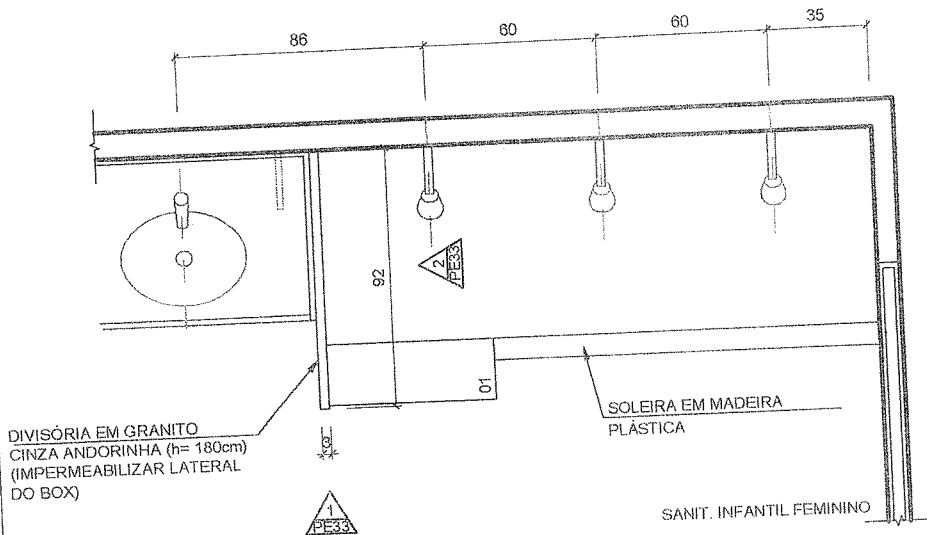
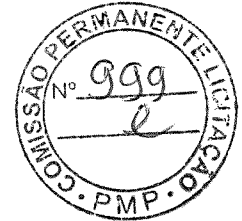
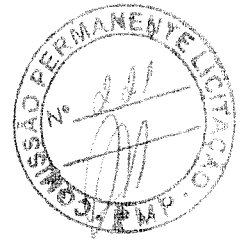

DIVISÓRIA EM GRANITO  
CINZA ANDORINHA (h= 180cm)  
(IMPERMEABILIZAR LATERAL  
DO BOX)

SOLEIRA EM MADEIRA  
PLÁSTICA

SANIT. INFANTIL FEMININO

OBS.: SANITÁRIO INFANTIL  
MASCULINO É ESPELHADO

01 PLANTA  
ESCALA 1:25

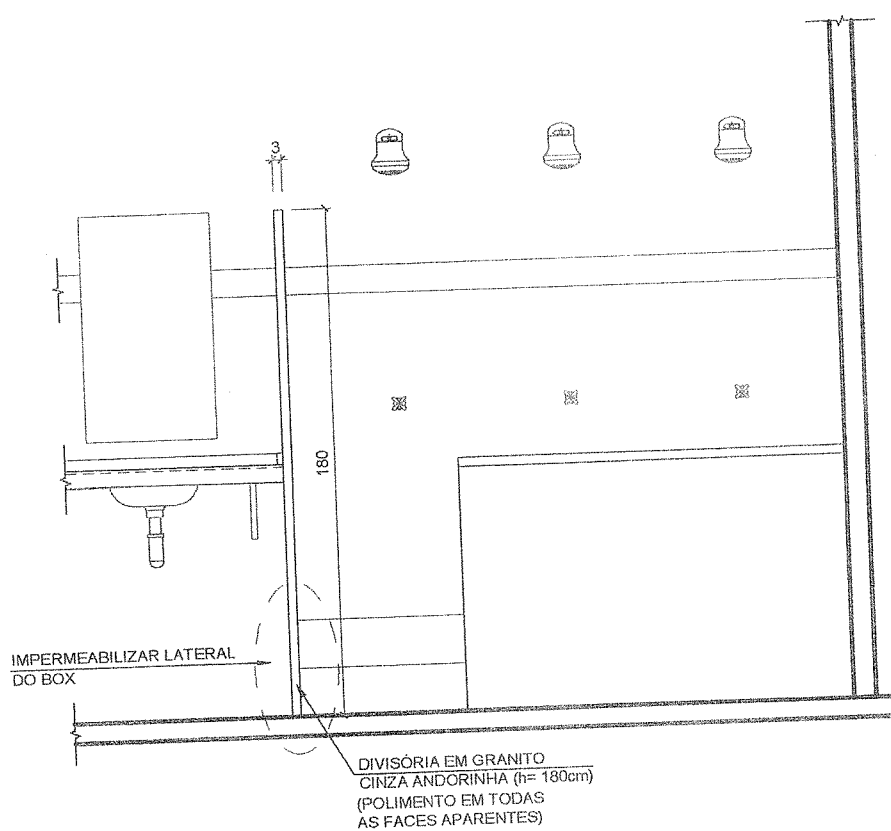

DIVISÓRIA EM GRANITO  
CINZA ANDORINHA (h= 180cm)  
(POLIMENTO EM TODAS  
AS FACES APARENTES)

02 ELEVAÇÃO 1  
ESCALA 1:25

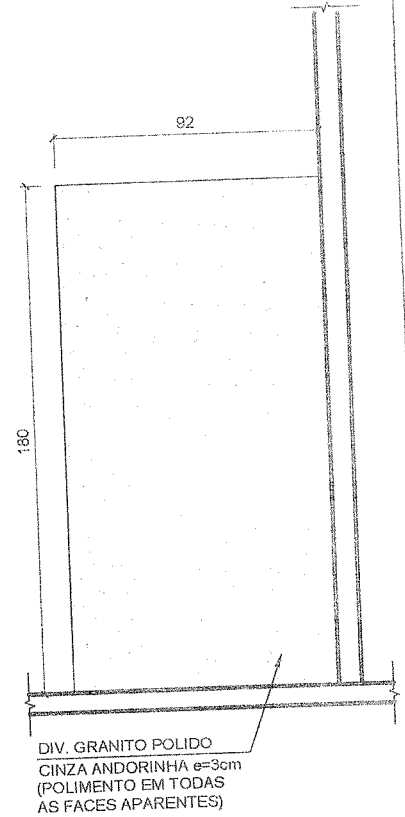

DIV. GRANITO POLIDO  
CINZA ANDORINHA e=3cm  
(POLIMENTO EM TODAS  
AS FACES APARENTES)

03 ELEVAÇÃO 2  
ESCALA 1:25

PLANTA SITUAÇÃO

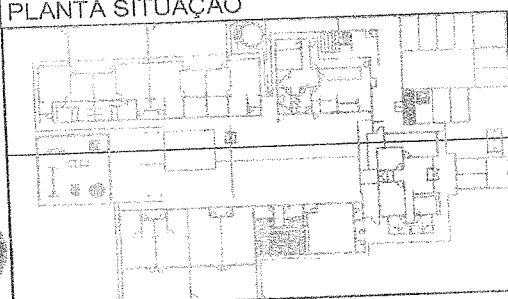

CRECHE TIPO B  
DETALHE DIVISÓRIA DV3-C  
SANIT. INFANTIL - BL. MULTIUSO

REV. 06

33/43

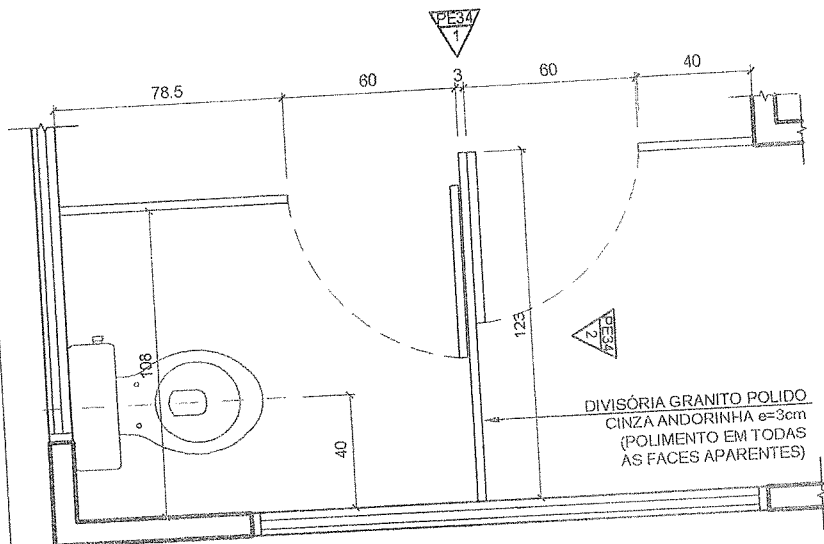
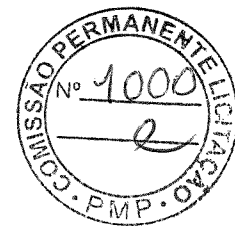

DIVISÓRIA GRANITO POLIDO  
CINZA ANDORINHA e=3cm  
(POLIMENTO EM TODAS  
AS FACES APARENTES)

01 PLANTA  
ESCALA 1:25

DIVISÓRIA GRANITO POLIDO  
CINZA ANDORINHA e=3cm  
(POLIMENTO EM TODAS  
AS FACES APARENTES)

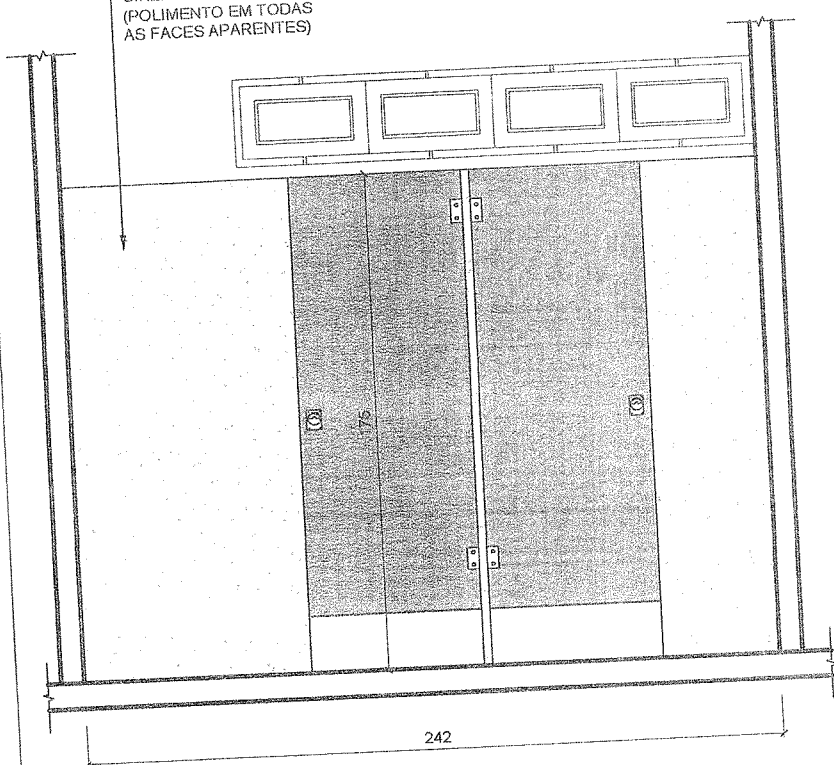

02 ELEVACÃO 1  
ESCALA 1:25

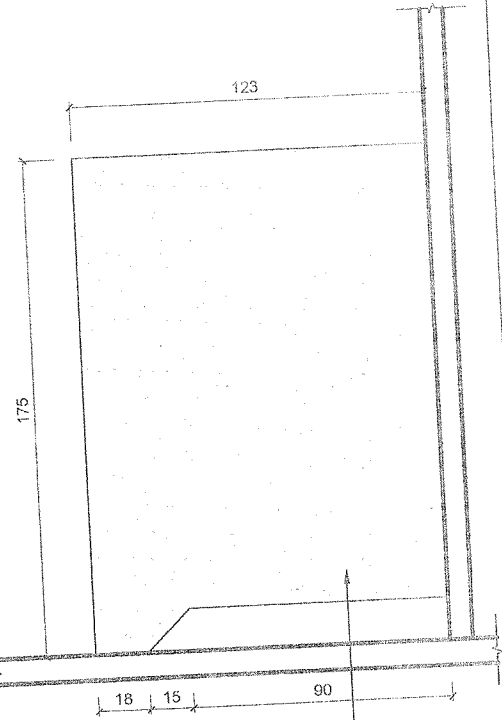

DIVISÓRIA GRANITO POLIDO  
CINZA ANDORINHA e=3cm  
(POLIMENTO EM TODAS  
AS FACES APARENTES)

03 ELEVACÃO 2  
ESCALA 1:25

PLANTA SITUAÇÃO

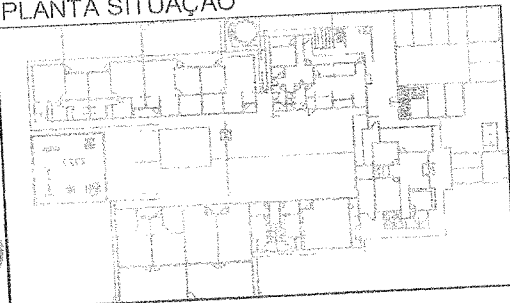

CRECHE TIPO B  
DETALHE DIVISÓRIA DV4-A  
SAN. FEM. - BL.ADMINISTRATIVO

REV. 06  
34/43



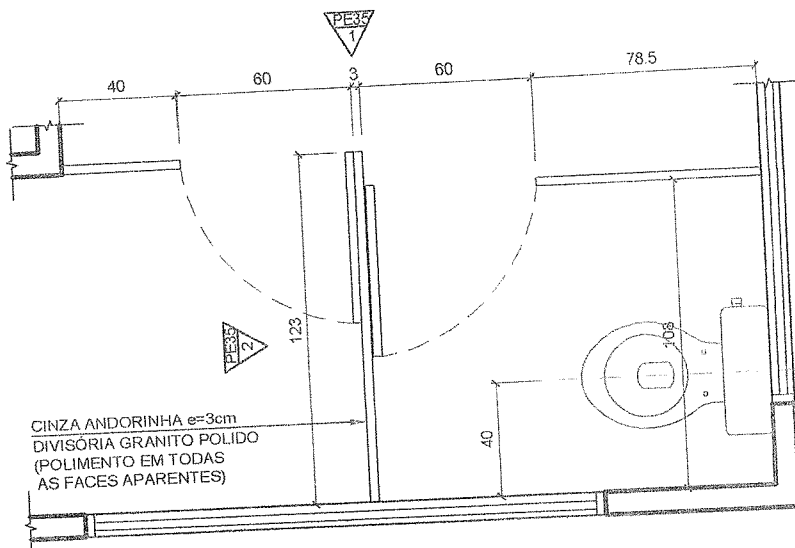

CINZA ANDORINHA e=3cm  
 DIVISÓRIA GRANITO POLIDO  
 (POLIMENTO EM TODAS  
 AS FACES APARENTES)

01 PLANTA  
 ESCALA 1:25

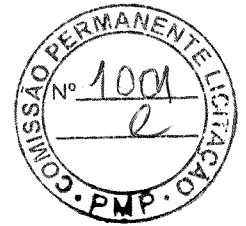
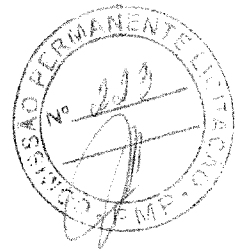

DIVISÓRIA GRANITO POLIDO  
 CINZA ANDORINHA e=3cm  
 (POLIMENTO EM TODAS  
 AS FACES APARENTES)

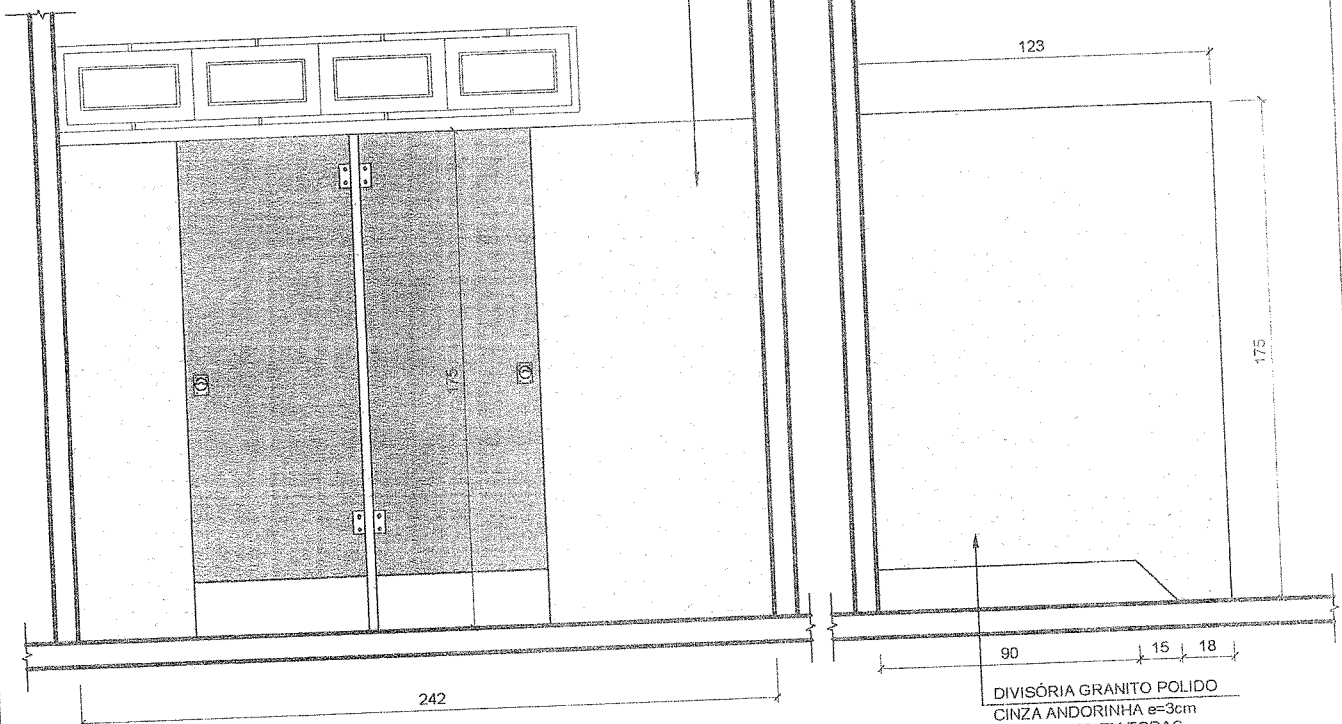

02 ELEVAÇÃO 1  
 ESCALA 1:25

03 ELEVAÇÃO 2  
 ESCALA 1:25

PLANTA SITUAÇÃO

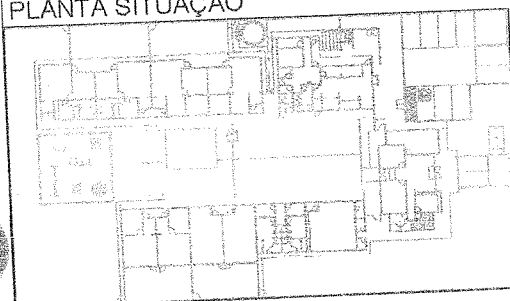

CRECHE TIPO B  
 DETALHE DIVISÓRIA DV4-B  
 SAN. MASC. - BL. ADMINISTRATIVO

REV. 06  
 35/43



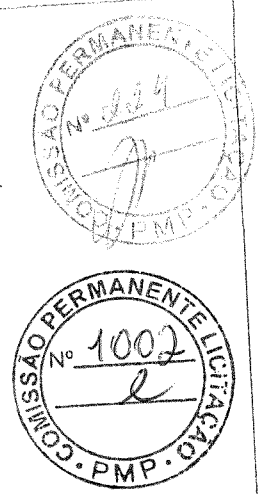
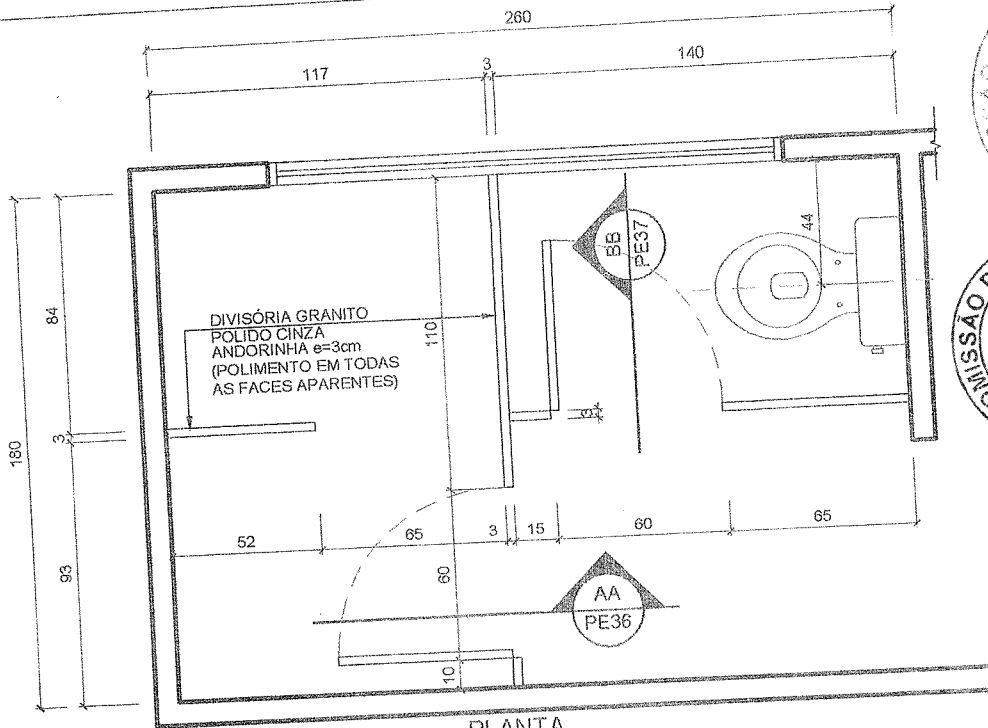

01 PLANTA  
ESCALA 1:25

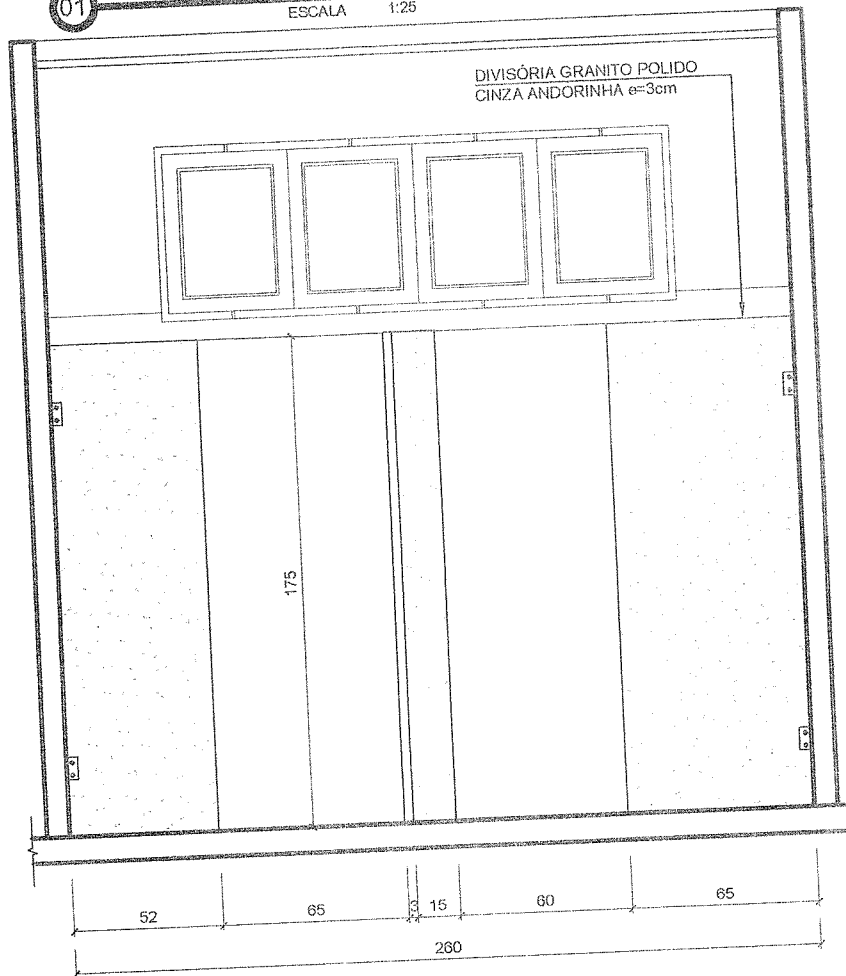

02 CORTE AA  
ESCALA 1:25

PLANTA SITUAÇÃO

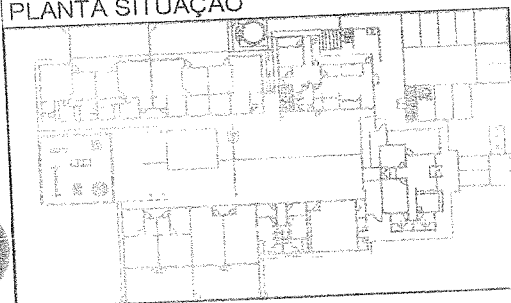

CRECHE TIPO B  
DETALHE DIVISÓRIA DV5-A  
VEST. MASCULINO - BL. SERVIÇO

REV. 06  
36/43

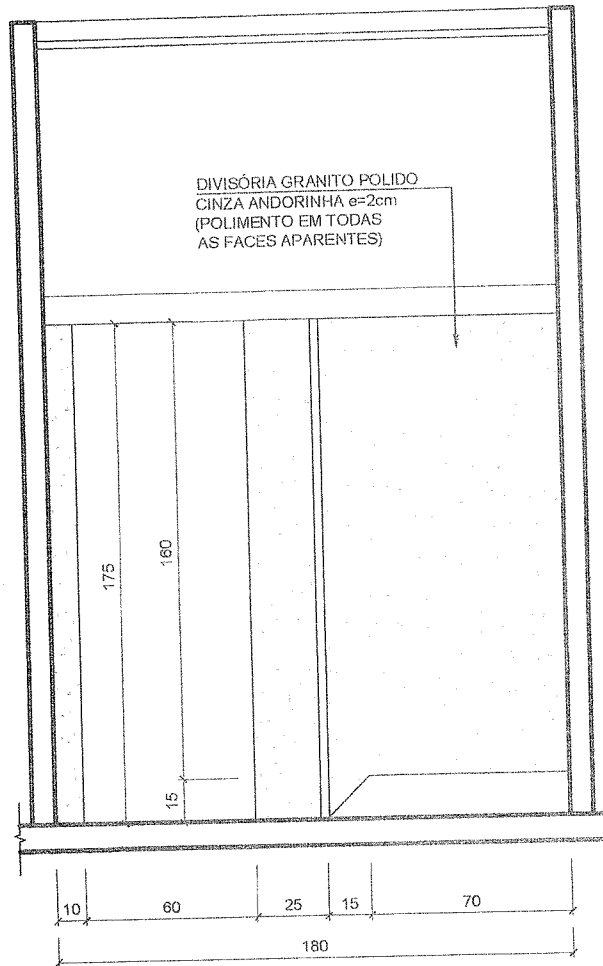
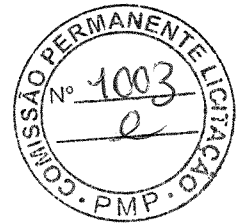
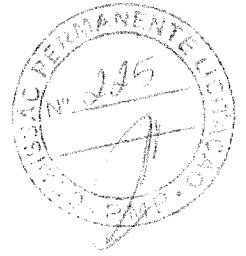

DIVISÓRIA GRANITO POLIDO  
CINZA ANDORINHA e=2cm  
(POLIMENTO EM TODAS  
AS FACES APARENTES)

01

CORTE BB  
ESCALA 1:25

PLANTA SITUAÇÃO

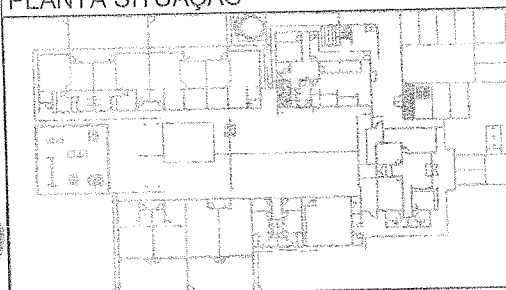

CRECHE TIPO B  
DETALHE DIVISÓRIA DV5-A  
VEST. MASCULINO - BL. SERVIÇO

REV. 06

37/43



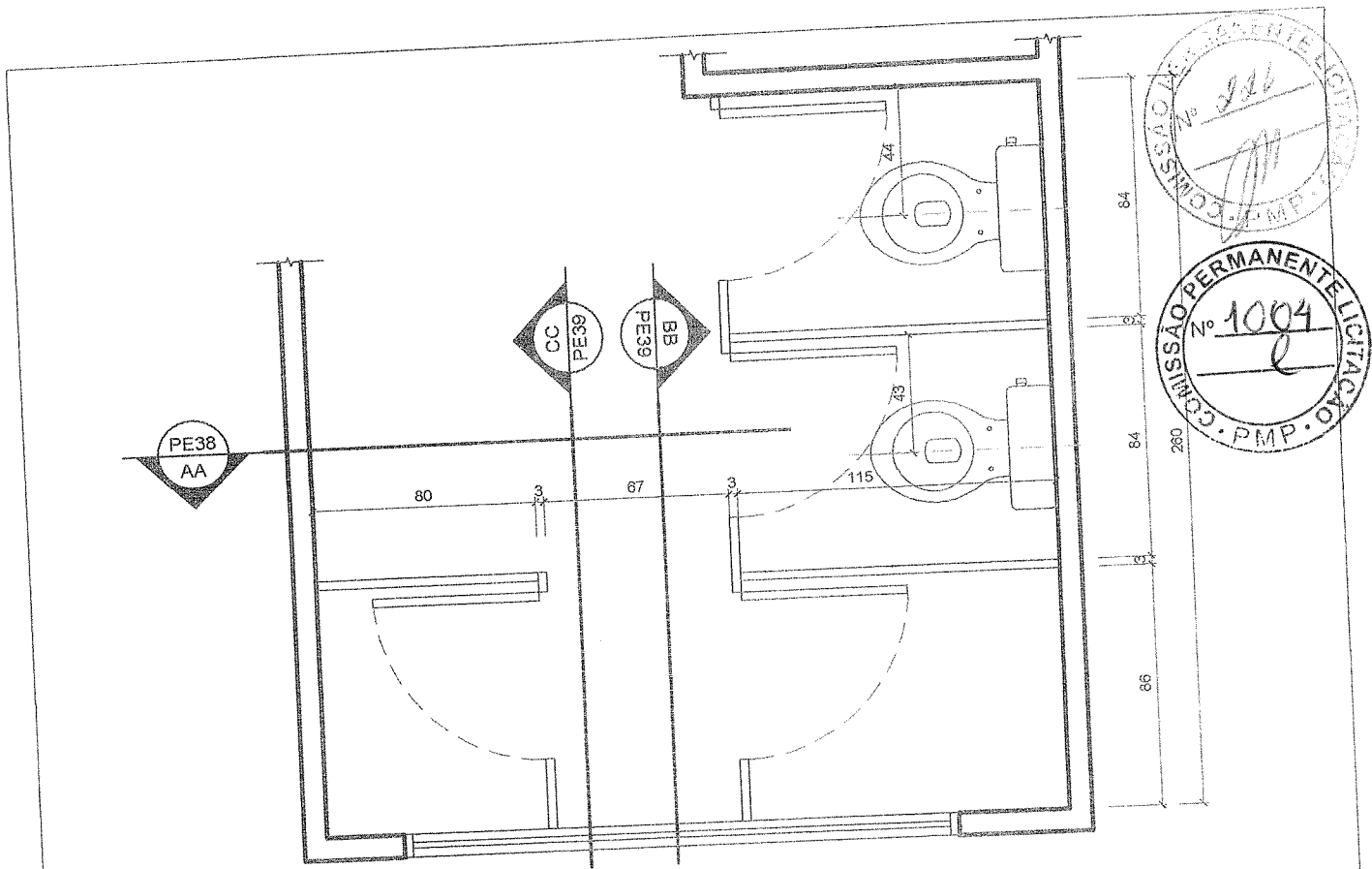

01 PLANTA  
ESCALA 1:25

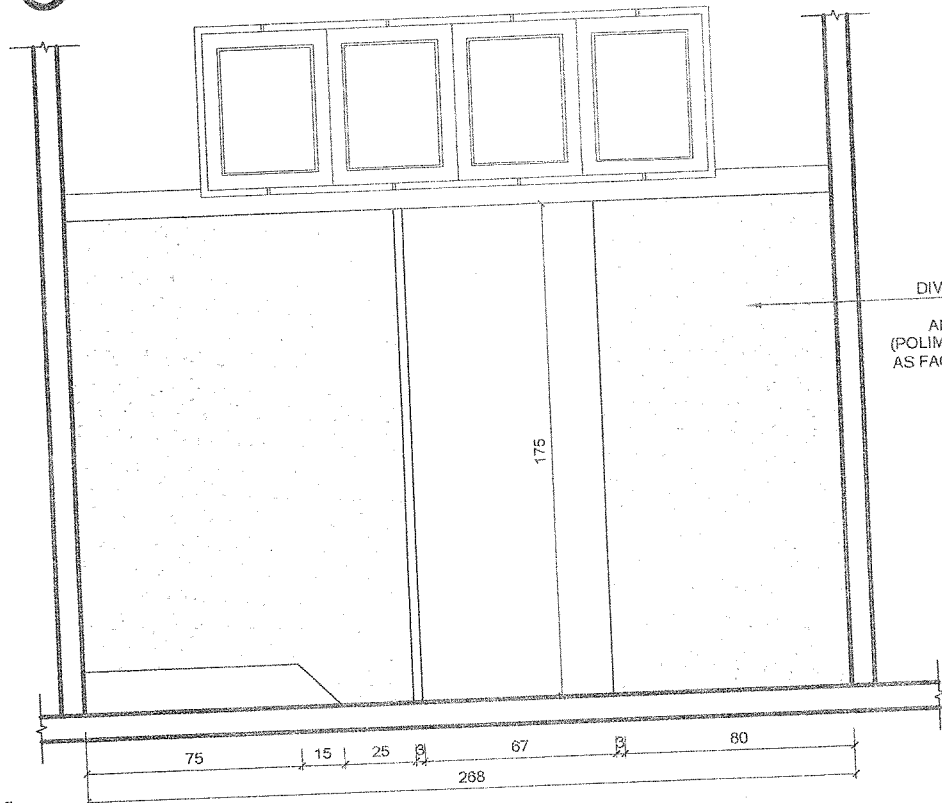

02 CORTE AA  
ESCALA 1:25

PLANTA SITUAÇÃO

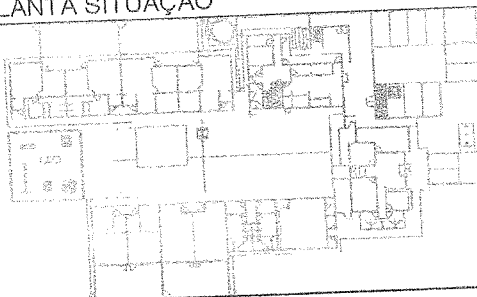

CRECHE TIPO B  
DETALHE DIVISÓRIA DV5-B  
VEST. FEMININO - BL. SERVIÇO

REV. 06

38/43

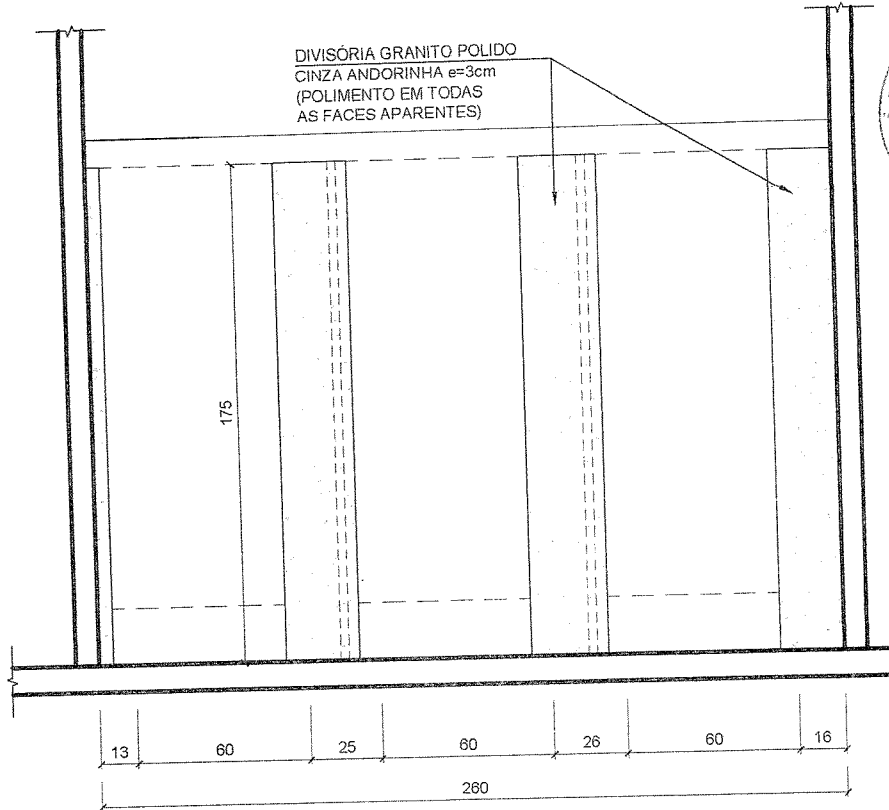
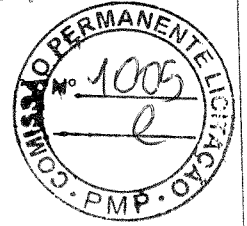
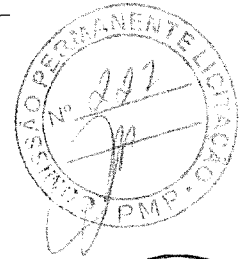

01 CORTE BB  
ESCALA 1:25

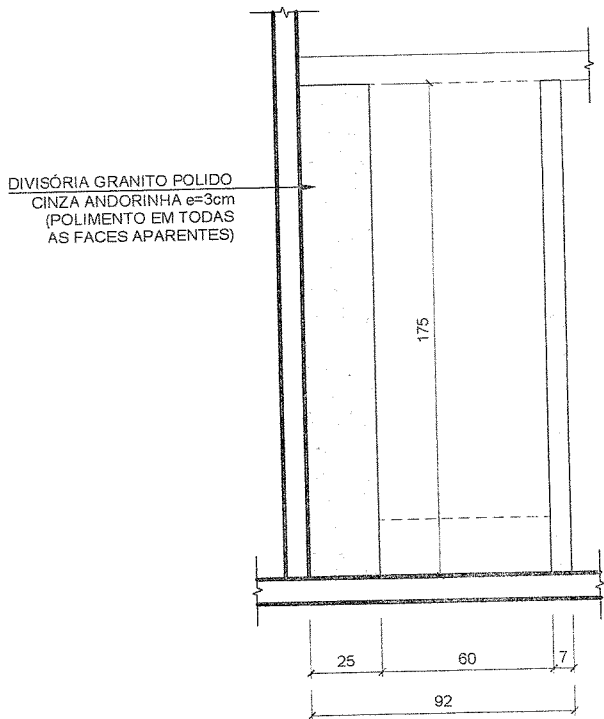

02 CORTE CC  
ESCALA 1:25

PLANTA SITUAÇÃO

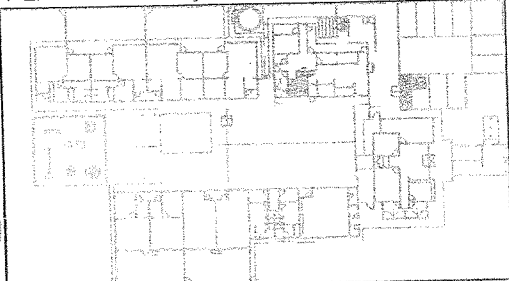

CRECHE TIPO B  
DETALHE DIVISÓRIA DV5  
VEST. FEMININO - BL. SERVIÇO

REV. 06  
39/43

