

OBS.: ESTE DESENHO CORRESPONDE ÀS PIAS QUE TÊM
ÁREA SECA E ÁREA MOLHADA NO MESMO TAMPO

D01 - BANCADAS ÁREA MOLHADA

ESCALA 1:2.5

01

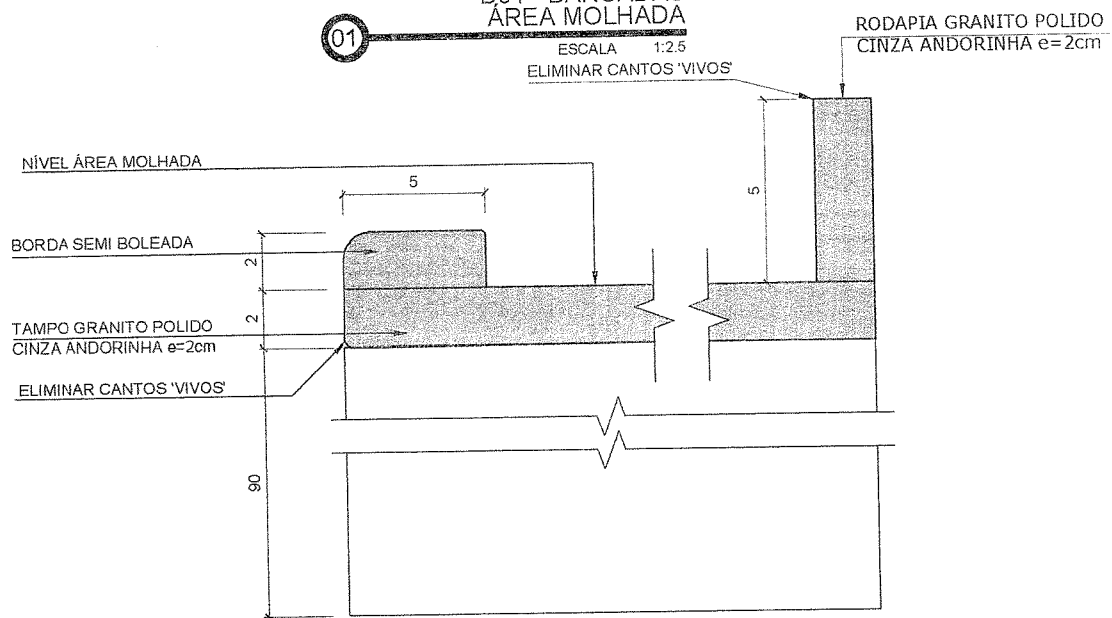

OBS.: ESTE DESENHO CORRESPONDE ÀS PIAS QUE TÊM
SOMENTE ÁREA MOLHADA (SEM ÁREA SECA)

D03 - BANCADAS ÁREA MOLHADA

ESCALA 1:2.5

02



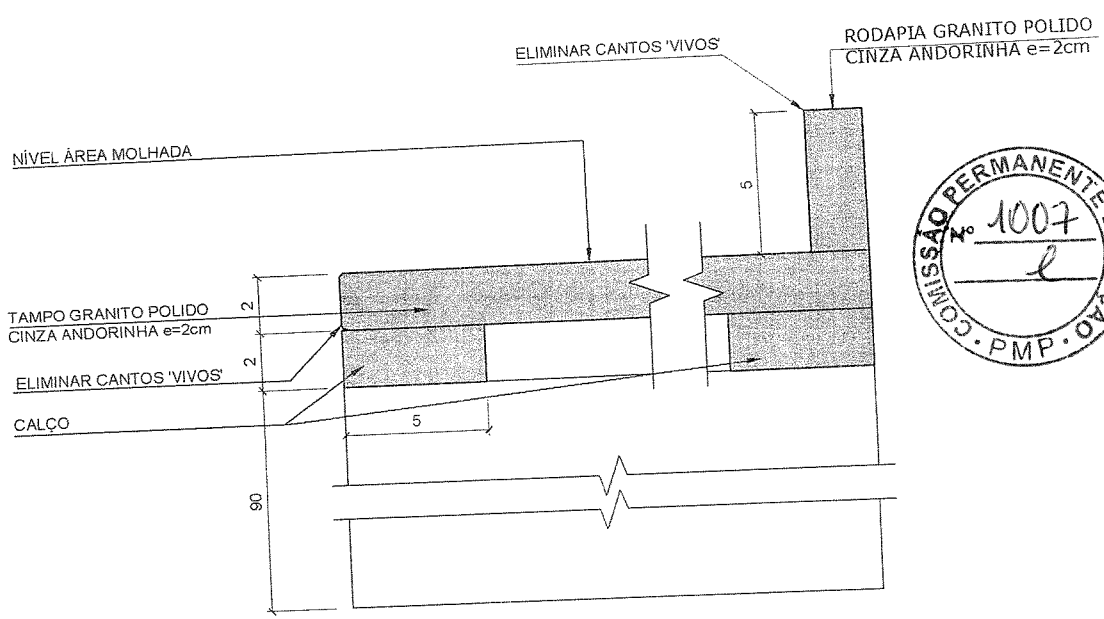
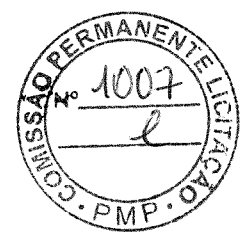
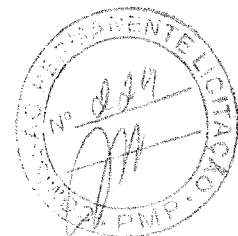

01 D02 - BANCADAS ÁREA SECA
ESCALA 1:2,5

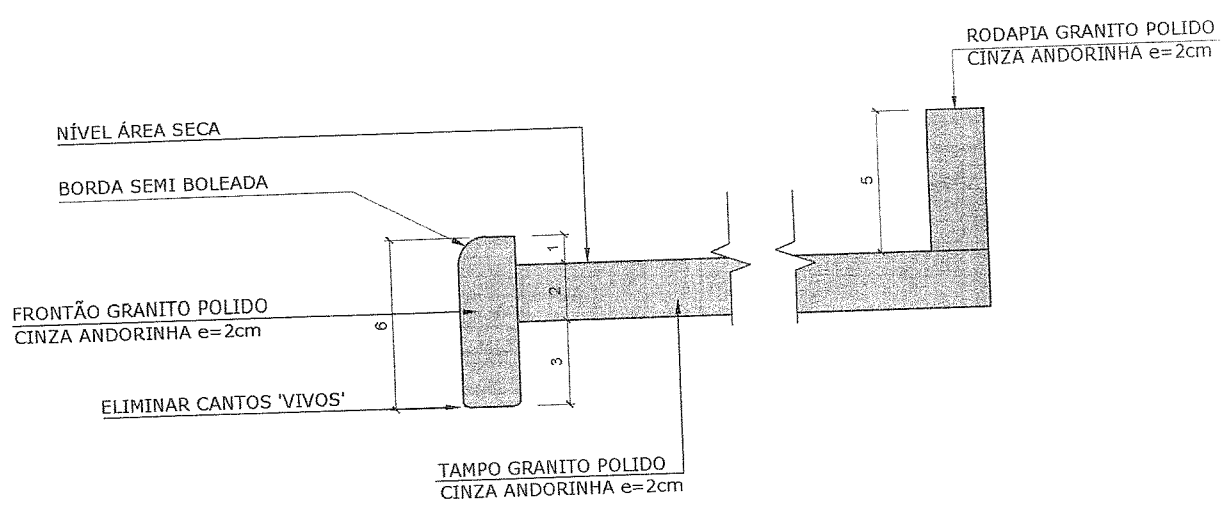

02 D04 - BANCADAS DETALHE FRONTÃO
ESCALA 1:2,5



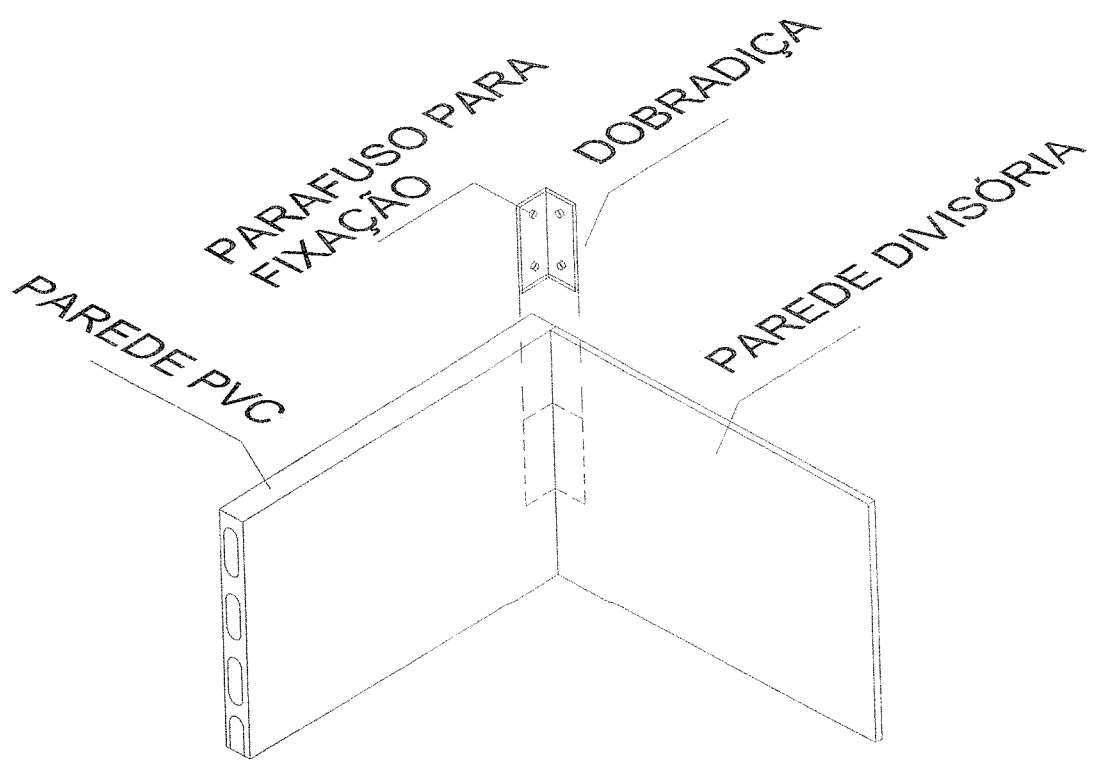
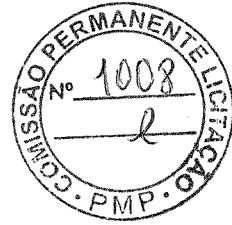

01 D05 - DIVISÓRIAS
DETALHE FIXAÇÃO
ESCALA —

CRECHE TIPO B
BANCADAS E DIVISÓRIAS
FIXAÇÃO - DOBRADIÇAS

REV. 06
42/43



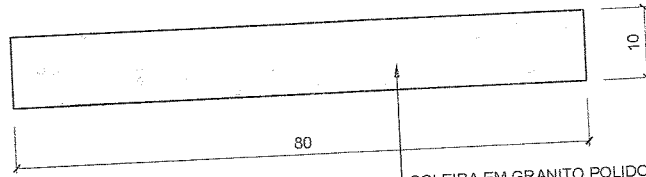
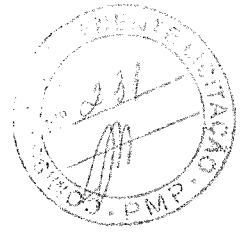

SOLEIRA EM GRANITO POLIDO
CINZA ANDORINHA 80 X 10 cm

01 DETALHE SOLEIRA 1
ESCALA 1:10

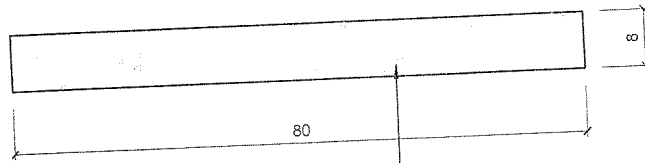

SOLEIRA EM GRANITO POLIDO
CINZA ANDORINHA 80 X 8 cm

02 DETALHE SOLEIRA 2
ESCALA 1:10

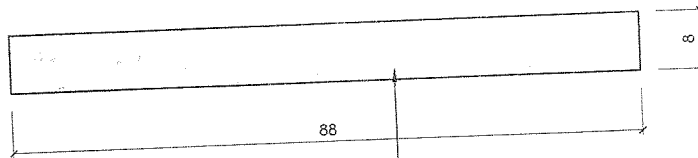

SOLEIRA EM GRANITO POLIDO
CINZA ANDORINHA 88 X 8 cm

03 DETALHE SOLEIRA 3
ESCALA 1:10

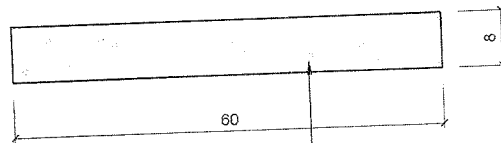

SOLEIRA EM GRANITO POLIDO
CINZA ANDORINHA 60 X 8 cm

04 DETALHE SOLEIRA 4
ESCALA 1:10

CRECHE TIPO B

REV. 06

43/43

DETALHE SOLEIRAS PORTAS

301CRB-DET-PE-001-GRA-GER-R06.dwg

DETALHES EM MDF CRECHE TIPO B

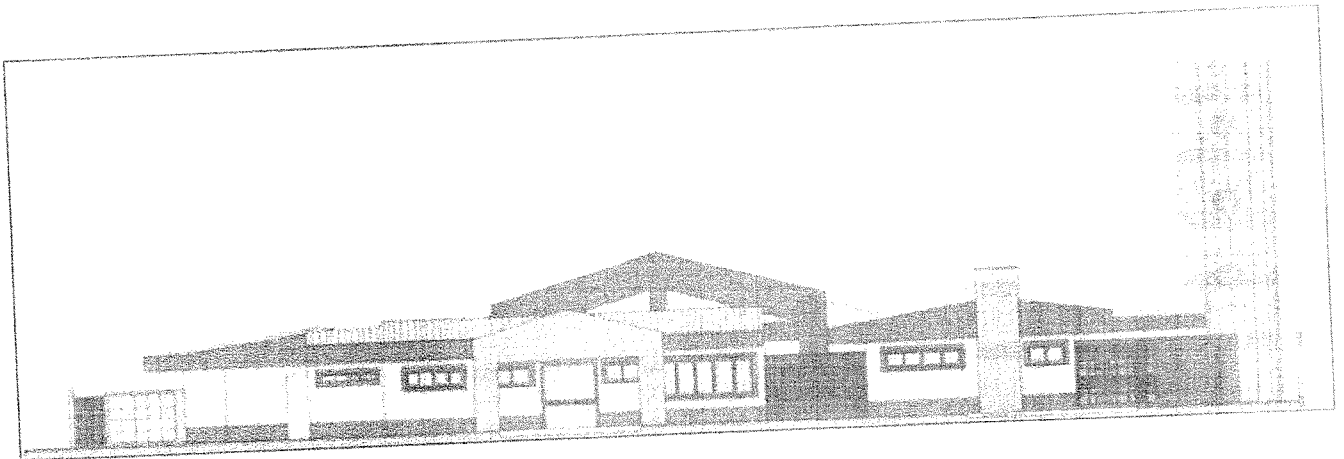
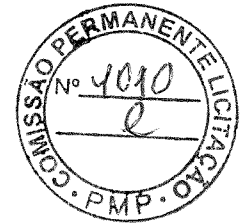
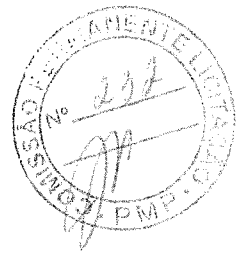

CASALTA
CONSTRUÇÕES

DETALHAMENTO PRATELEIRAS
E ESCANINHOS

REV. 05

01/16

MDF
(MDF)
(VERIFICAR MEDIDAS NA OBRA)
EMISSÃO: AGOSTO / 2013



REV.	DATA	FOLHA	DESCRIÇÃO
R00	AGOSTO/2013	-	EMISSÃO INICIAL
R01	FEVEREIRO/2014	-	ALTERAÇÃO DAS QUANTIDADES DE PRATELEIRAS E DIMENSÕES DO PT5, PT7, E PT8, INCLUSÃO DA PT10 E PT 11
R02	SETEMBRO/2014	-	ALTERAÇÃO DAS DIMENSÕES DAS PRATELEIRAS PT10 E PT 11.
R03	DEZEMBRO/2014	-	ALTERAÇÃO DAS DIMENSÕES ESCANINHO CONFORME PROJETO ARQUITETONICO
R04	DEZEMBRO/2014	-	ALTERAÇÃO DAS DIMENSÕES ESCANINHO CONFORME PROJETO ARQUITETONICO
R05	MARÇO/2015	-	REVISÃO DE TODO CADERNO CONFORME PROJETO ARQUITETÔNICO

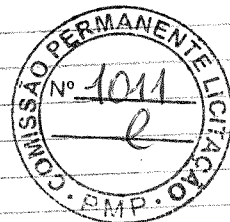

ÍNDICE DE DETALHES DE PRATELEIRAS E ESCANINHOS

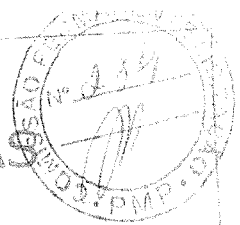

CÓD.	DIMENSÕES (cm) (COMP x PROF)	MATERIAL	TIPO	LOCAL	QTD.
PRATELEIRA EM MDF					
PT1	192x50 e 190x40cm	MDF BRANCO 25mm	PRATELEIRA BORDA BOLEADA, S/ CANTO VIVO	SALA BLOCO MULTIUSO	01
PT2	348 e 260x40cm	MDF BRANCO 25mm	PRATELEIRA BORDA BOLEADA, S/ CANTO VIVO	ALMOXARIFADO BLOCO ADM.	02
PT3	116 x 50cm	MDF BRANCO 25mm	PRATELEIRA BORDA BOLEADA, S/ CANTO VIVO	COZINHA BLOCO SERVIÇO	04
PT4	120 x 65cm	MDF BRANCO 25mm	PRATELEIRA BORDA BOLEADA, S/ CANTO VIVO	COZINHA BLOCO SERVIÇO	04
PT5	246x30 e 160x50	MDF BRANCO 25mm	PRATELEIRA BORDA BOLEADA, S/ CANTO VIVO	DESPENSA BLOCO SERVIÇO	03
PT6	180 x 35cm	MDF BRANCO 25mm	PRATELEIRA BORDA BOLEADA, S/ CANTO VIVO	DML - BLOCO SERVIÇO	03
PT7	348 x 30cm	MDF BRANCO 25mm	PRATELEIRA BORDA BOLEADA, S/ CANTO VIVO	LAVANDERIA BLOCO SERVIÇO	01
PT8	348x30/40cm e 100/30cm	MDF BRANCO 25mm	PRATELEIRA BORDA BOLEADA, S/ CANTO VIVO	ROUPARIA BLOCO SERVIÇO	03
PT9	106 x 35cm	MDF BRANCO 25mm	PRATELEIRA BORDA BOLEADA, S/ CANTO VIVO	CIRCULAÇÃO BLOCO SERVIÇO	03
PT10	134 x 20cm	MDF BRANCO 25mm	PRATELEIRA BORDA BOLEADA, S/ CANTO VIVO	FRALDÁRIO	02
PT11	288 x 20cm	MDF BRANCO 25mm	PRATELEIRA BORDA BOLEADA, S/ CANTO VIVO	FRALDÁRIO	02
ESCANINHOS EM MDF					
EC1/EC2	160 x 40cm	MDF BRANCO 25mm	ESCANINHO	SALAS CRECHE I E II	04
EC3	228 x 40cm	MDF BRANCO 25mm	ESCANINHO	SALAS CRECHE III	02

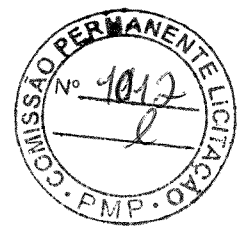

OBSERVAÇÕES

- * CONFIRMAR MEDIDAS NA OBRA.
- * TODAS AS PRATELEIRAS E ESCANINHOS SERÃO EM MDF BRANCO COM ESPESSURA DE 25mm.
- * TODAS AS PRATELEIRAS E ESCANINHOS FORAM REPRESENTADOS NA ESCALA 1/25, EXCETO QUANDO INDICADA.

CASALTA
CONSTRUTORES

CRECHE TIPO B
ÍNDICE PRATELEIRAS
E ESCANINHOS

REV. 06

03/16

PLANTA SITUAÇÃO

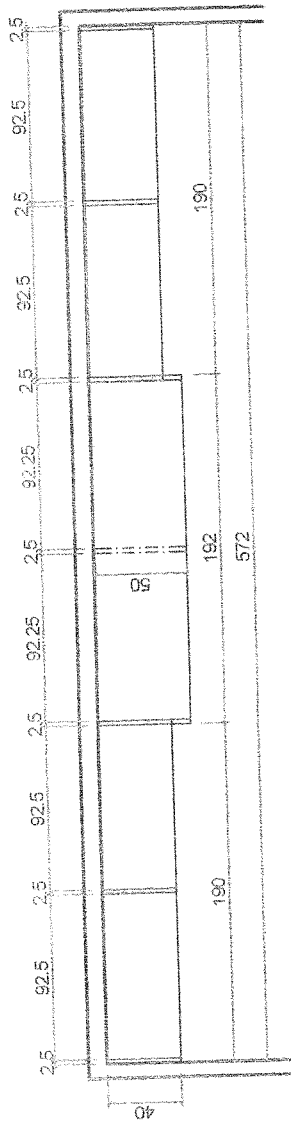
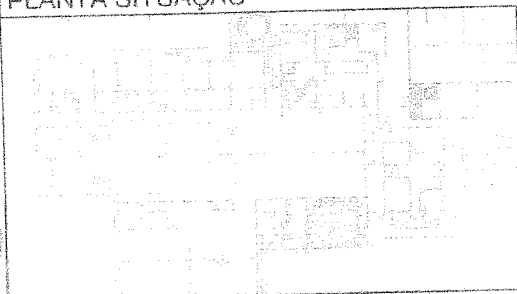

PLANTA
ESCALA 1:40

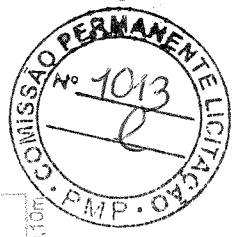
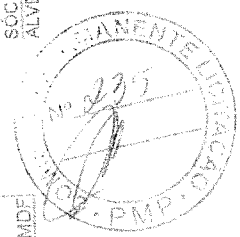
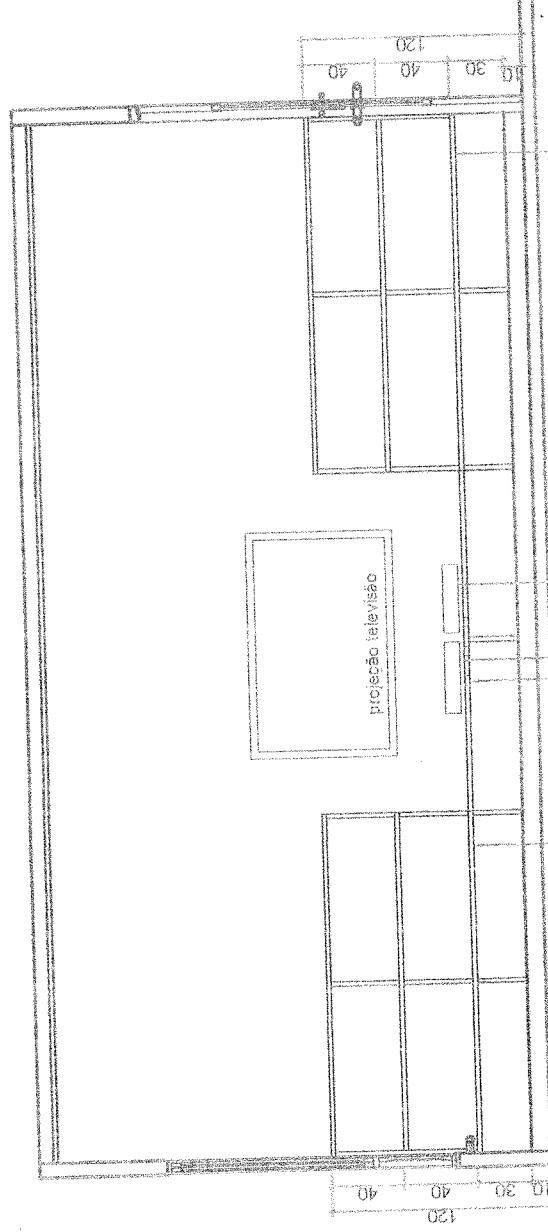
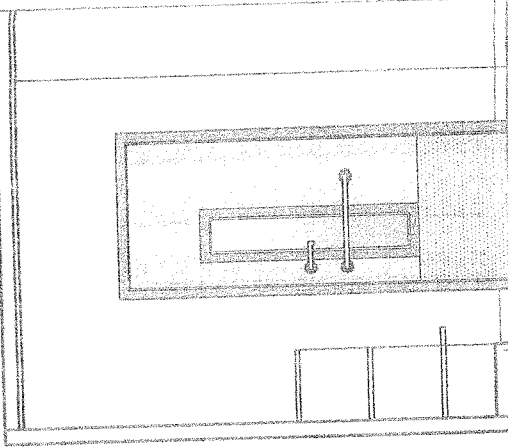

SÓCULO DE ALVENARIA h=0,10m

PRATELEIRA EM MDF BRANCO 25mm

PASSA-FIOS PROJECÇÃO SOM

PRATELEIRA EM MDF BRANCO 25mm

SÓCULO DE ALVENARIA h=0,10m

PRATELEIRA EM MDF BRANCO 25mm

ELEVACÃO
ESCALA 1:40

CRECHE TIPO B
DETALHE PRATELEIRA PT1
BLOCO MULTIUSO

REV. 05
04/16

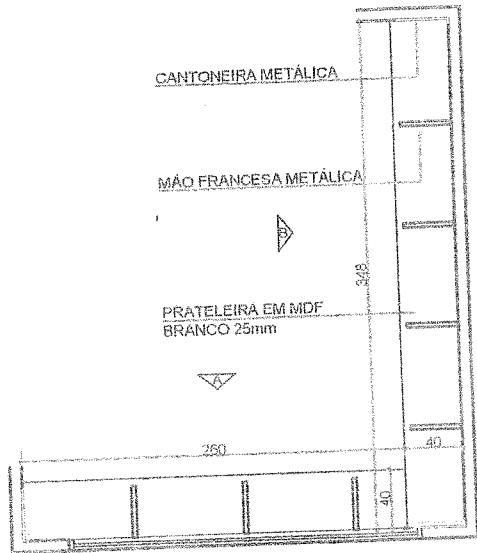
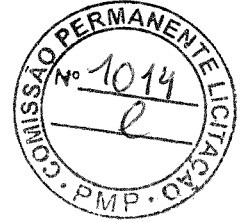
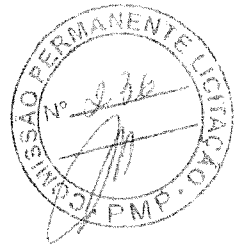

01 PLANTA
ESCALA 1:50

PRATELEIRA EM MDF
BRANCO 25mm

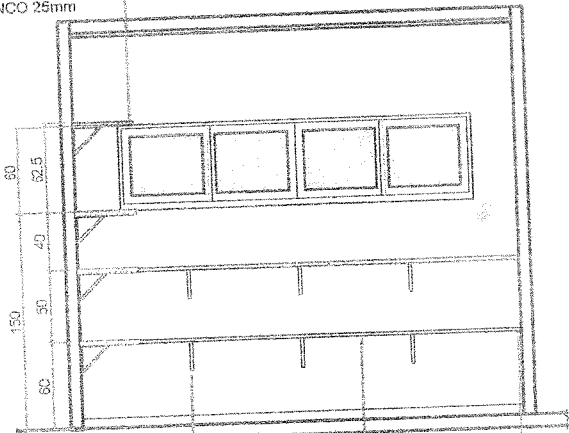

MÃO FRANCESA METÁLICA PINTURA COR CINZA
PRATELEIRA EM MDF BRANCO 25mm
CANTONEIRA METÁLICA PINTURA COR CINZA

02 ELEVAÇÃO A
ESCALA 1:50

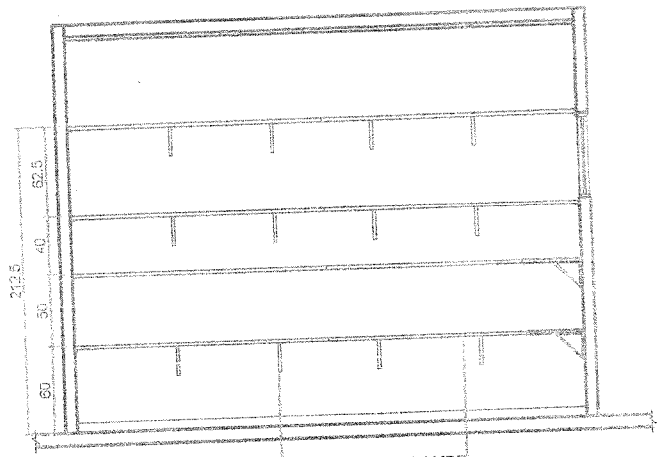

MÃO FRANCESA METÁLICA PINTURA COR CINZA
PRATELEIRA EM MDF BRANCO 25mm

03 ELEVAÇÃO B
ESCALA 1:50

PLANTA SITUAÇÃO

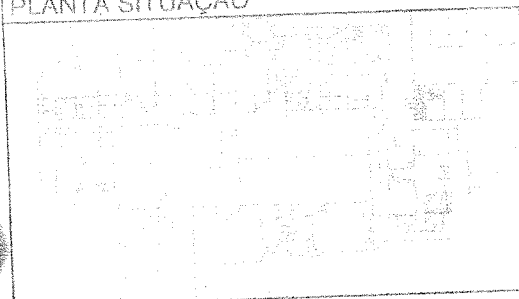

CRECHE TIPO B
DETALHE PRATELEIRA PT02
ALMOXARIFADO

REV. 05

05/16

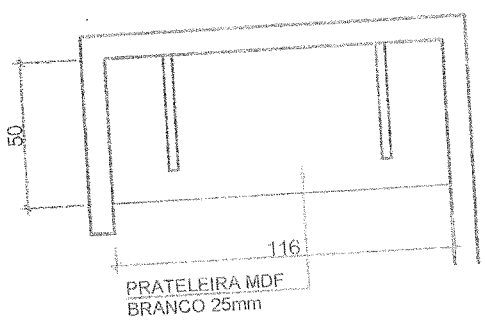
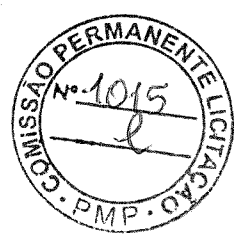

01 PLANTA
ESCALA 1:25

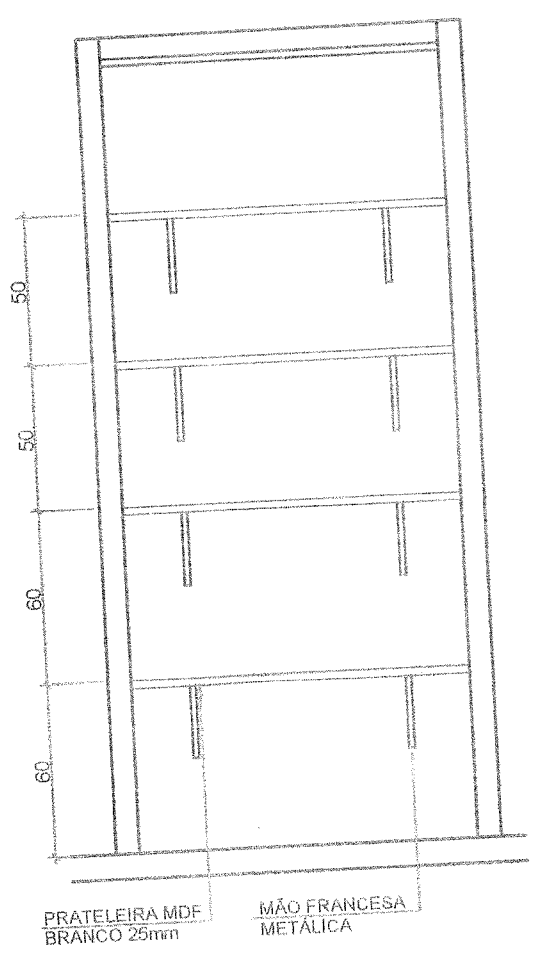

02 ELEVÇÃO
ESCALA 1:25

PLANTA SITUAÇÃO

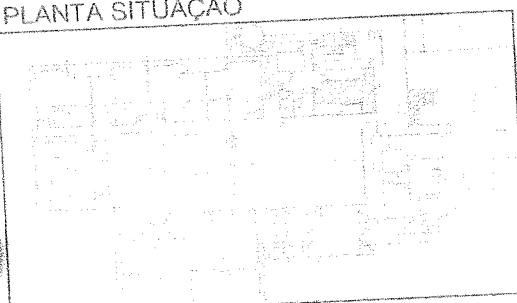

CRECHE TIPO B
DETALHE PRATELEIRA PT03
COZINHA

REV. 05
06/16



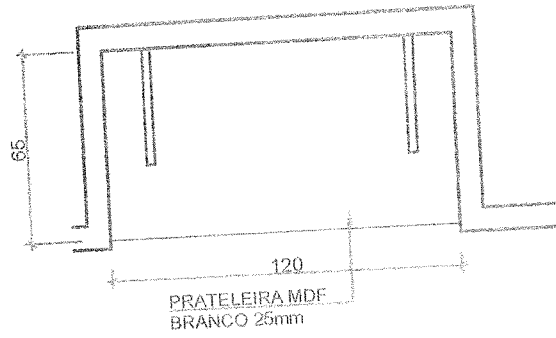
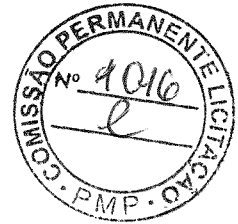

01

PRATELEIRA MDF
BRANCO 25mm

PLANTA
ESCALA 1:25

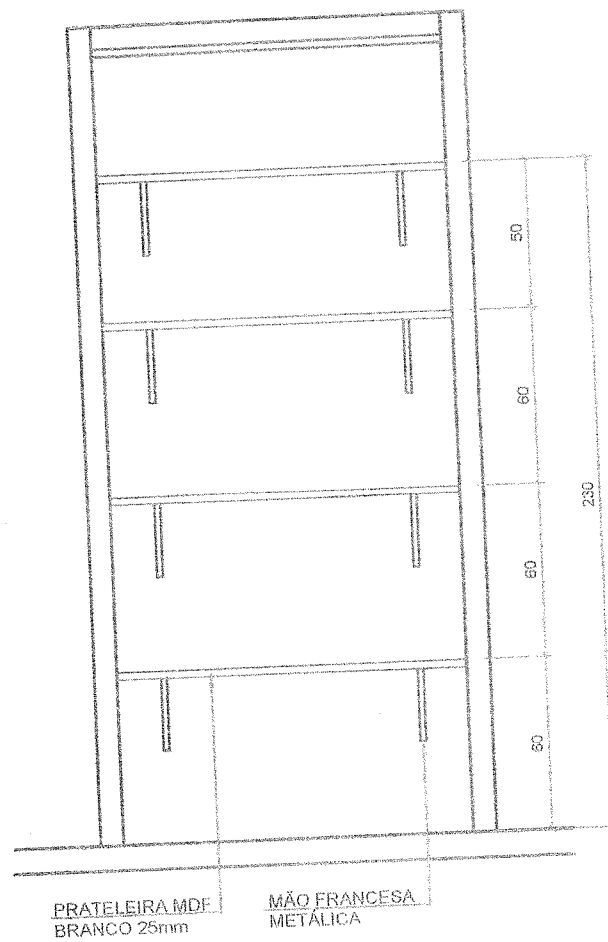

PRATELEIRA MDF
BRANCO 25mm

MÃO FRANCESA
METÁLICA

02

ELEVAÇÃO
ESCALA 1:25

PLANTA SITUAÇÃO

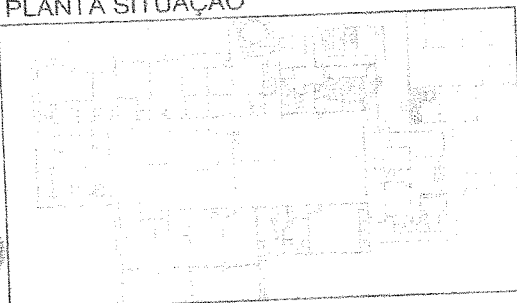

CRECHE TIPO B
DETALHE PRATELEIRA PT04
COZINHA

REV. 05

07/16



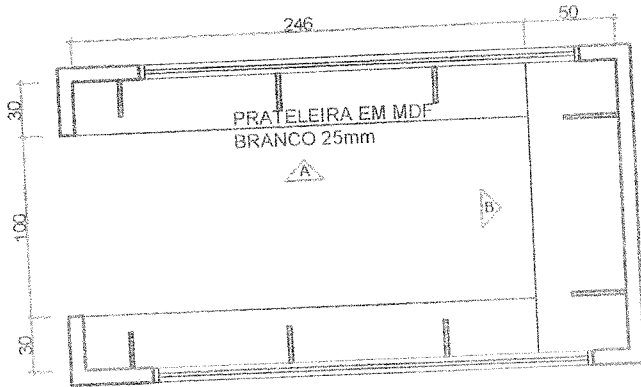
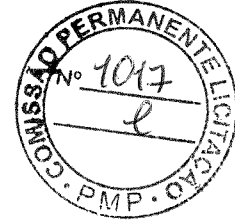

01 PLANTA
ESCALA 1:40

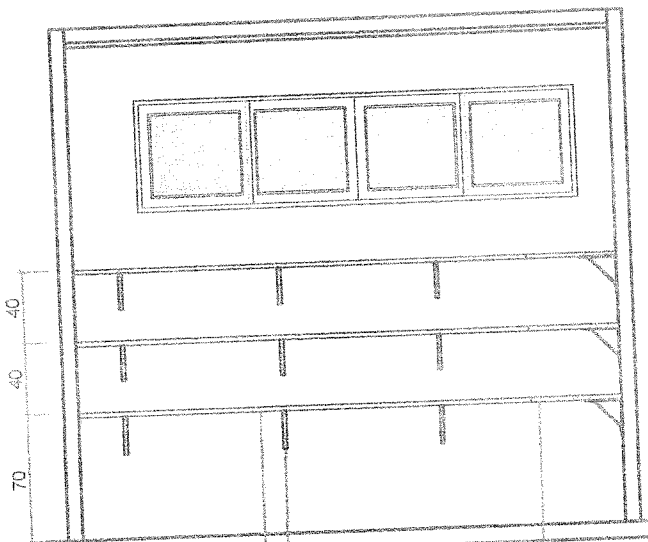

PRATELEIRA EM MDF BRANCO 25mm MÃO FRANCESA METÁLICA PRATELEIRA EM MDF BRANCO 25mm

02 ELEVÇÃO A
ESCALA 1:40

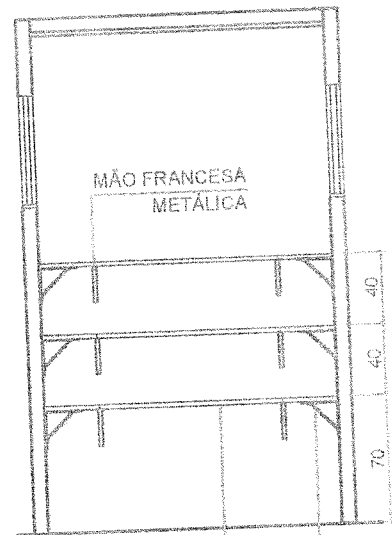

PRATELEIRA EM MDF BRANCO 25mm MÃO FRANCESA METÁLICA PRATELEIRA EM MDF BRANCO 25mm

03 ELEVÇÃO B
ESCALA 1:40

PLANTA SITUAÇÃO

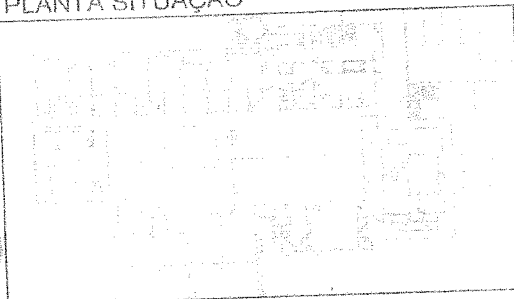

CRECHE TIPO B
DETALHE PRATELEIRA PT05
DESPENSA

REV. 05

08/16



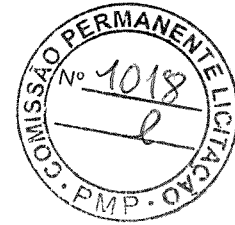

01 PLANTA
ESCALA 1:25

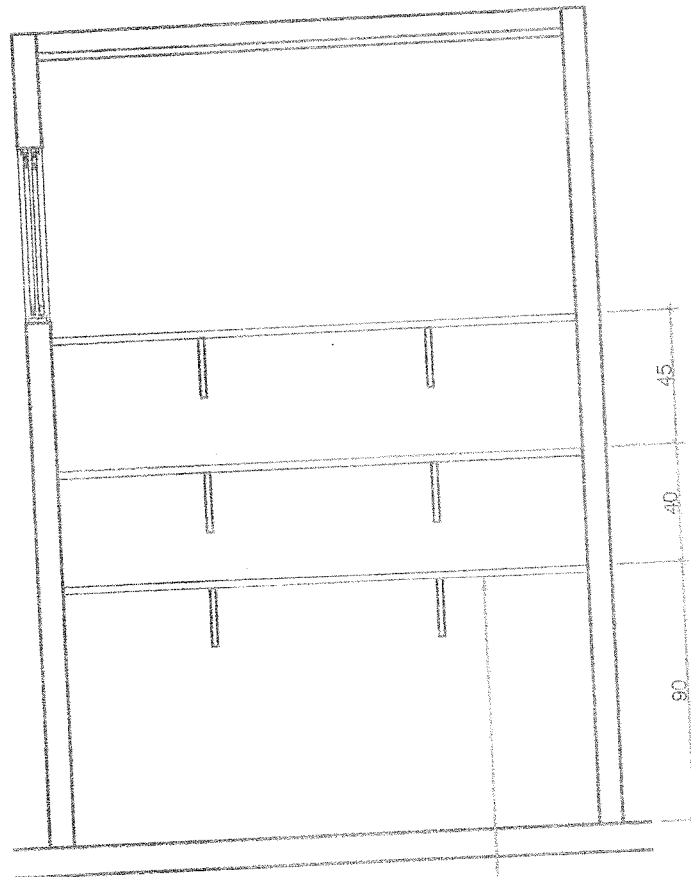

02 ELEVACÃO
ESCALA 1:25

PLANTA SITUAÇÃO

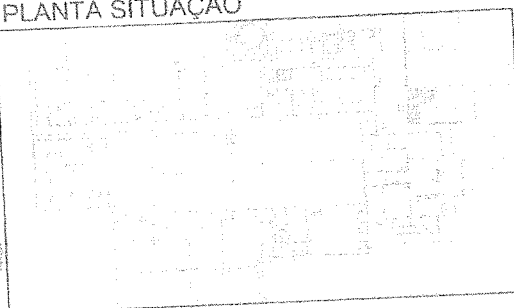

CRECHE TIPO B
DETALHE PRATELEIRA PT06
D.M.L.

REV. 00

09/16



348

30

PRATELEIRA MDF
BRANCO 25mm

MURETA de 1,20m

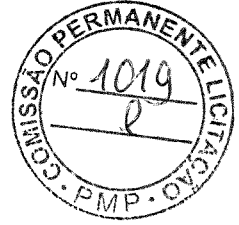

01

PLANTA
ESCALA 1:25

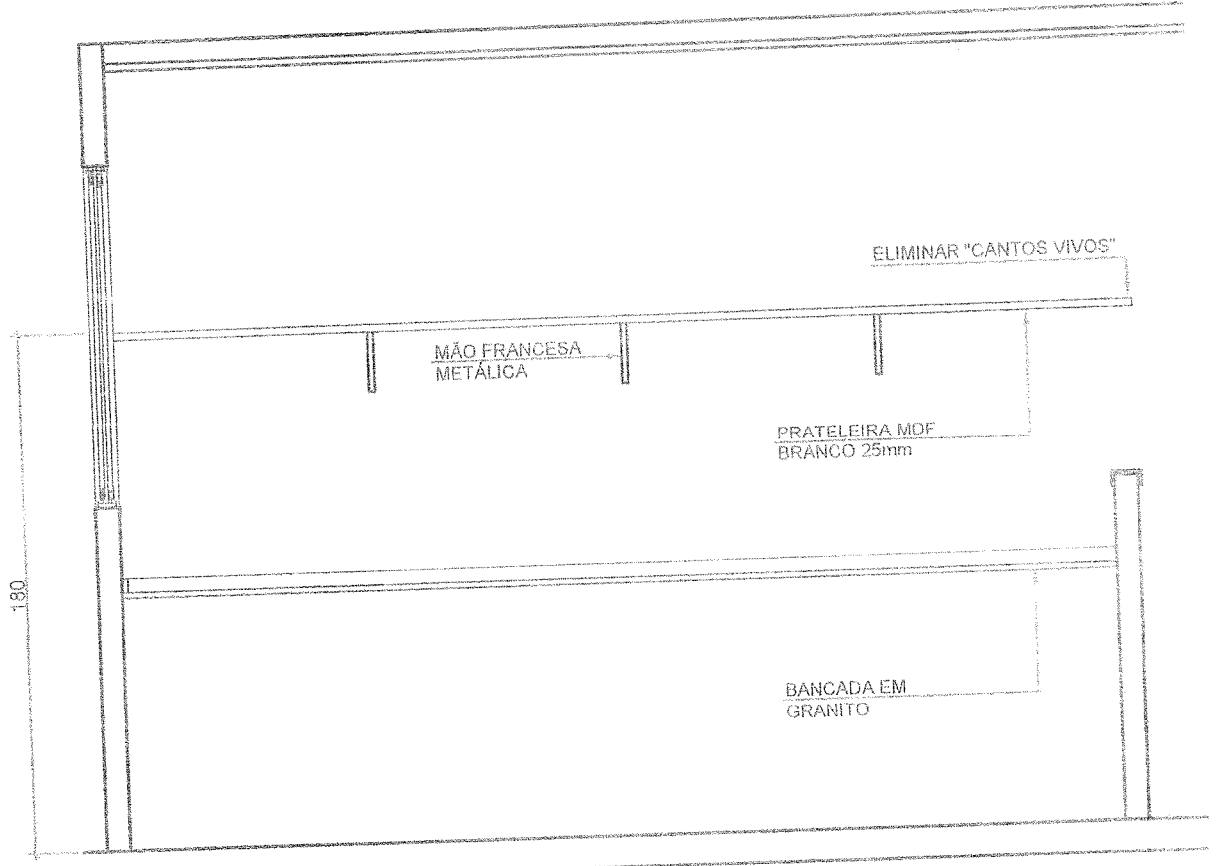

ELIMINAR "CANTOS VIVOS"

MÃO FRANCESA
METÁLICA

PRATELEIRA MDF
BRANCO 25mm

BANCADA EM
GRANITO

180

02

ELEVAÇÃO
ESCALA 1:25

PLANTA SITUAÇÃO

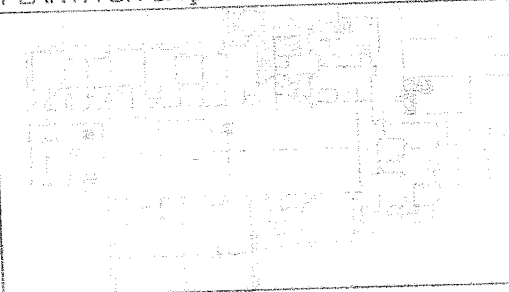

CRECHE TIPO B
DETALHE PRATELEIRA PT07
LAVANDERIA

REV. 05

10/16



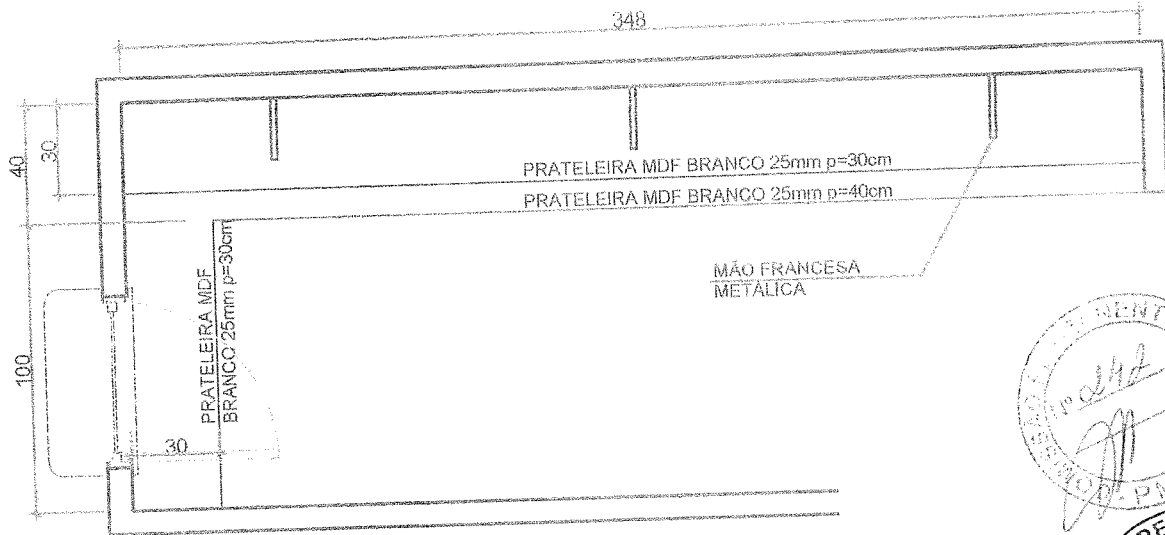

01 PLANTA
ESCALA 1:25

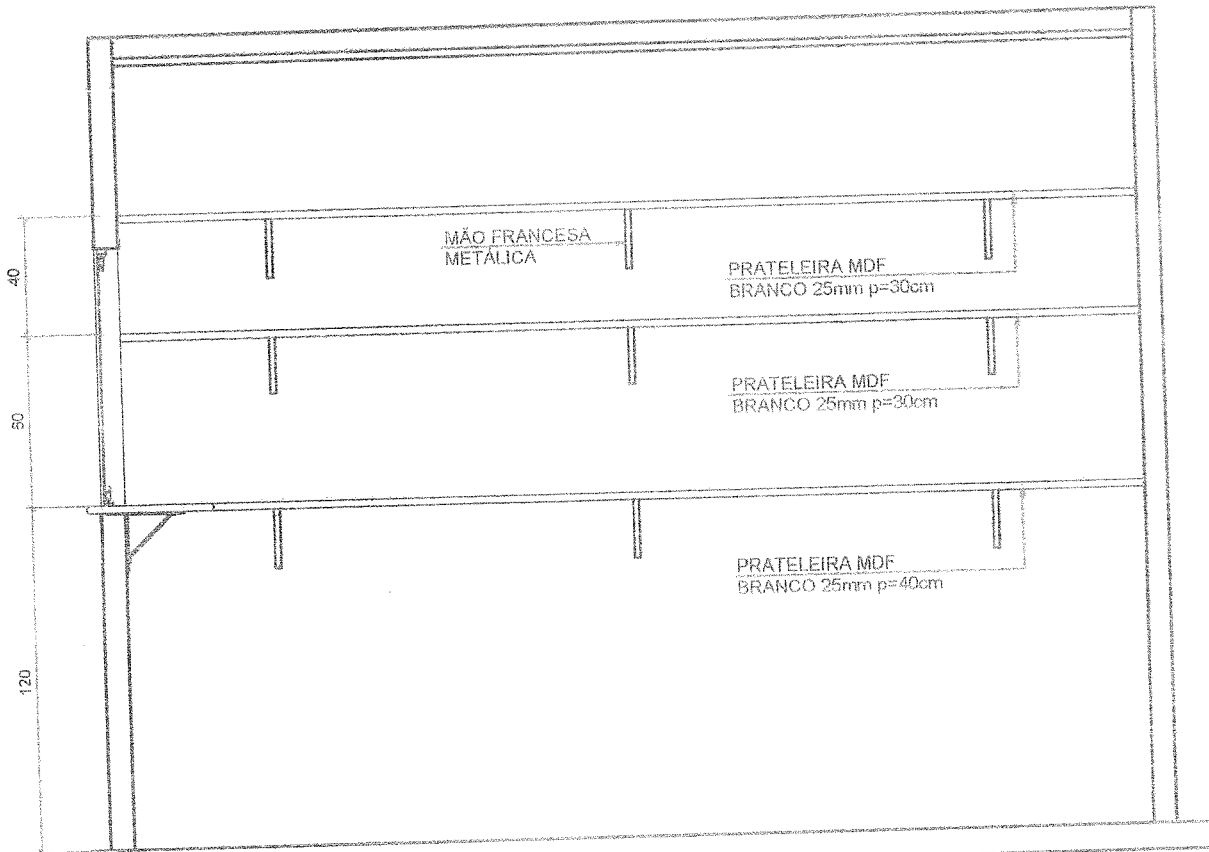
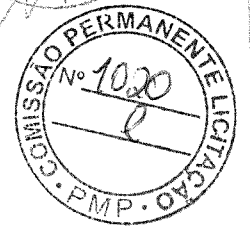
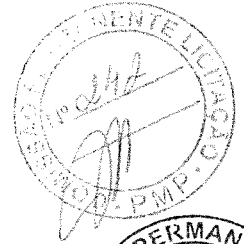

02 ELEVACÃO
ESCALA 1:25

PLANTA SITUAÇÃO

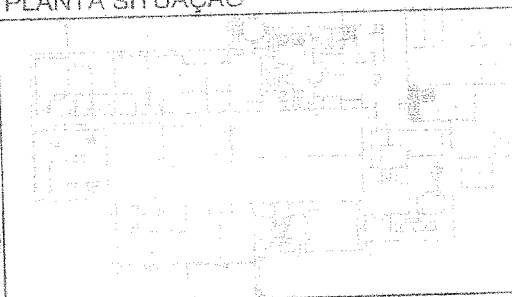

CRECHE TIPO B
DETALHE PRATELEIRA PT08
ROUPARIA

REV. 05
11/16

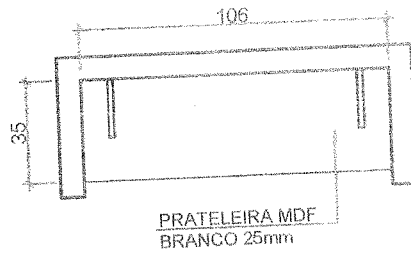

PRATELEIRA MDF
BRANCO 25mm

01

PLANTA

ESCALA 1:25

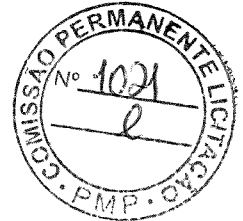

MÃO FRANCESA
METALICA

PRATELEIRA MDF
BRANCO 25mm

02

ELEVAÇÃO

ESCALA 1:25

PLANTA SITUAÇÃO

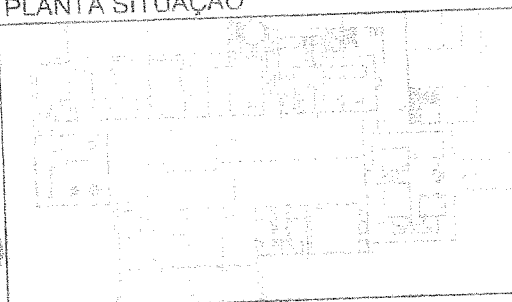

CRECHE TIPO B
DETALHE PRATELEIRA PT09
CIRCULAÇÃO

REV. 05

12/16



PRATELEIRA EM MDF
BRANCO 25mm

20

134

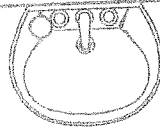

ELIMINAR "CANTOS VIVOS"

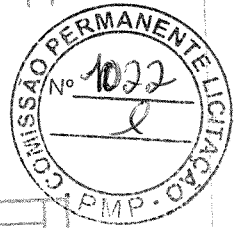
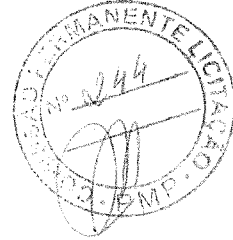

01

PLANTA
ESCALA 1:25

PRATELEIRA PT10
MDF BRANCO 25mm

BANCADA EM GRANITO
CINZA ANDORINHA

150

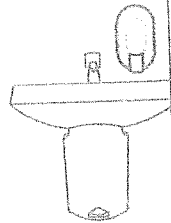

02

ELEVAÇÃO
ESCALA 1:25

PLANTA SITUAÇÃO

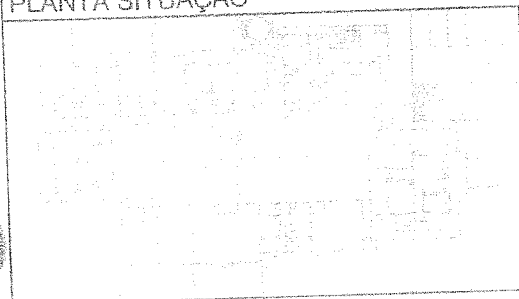

CRECHE TIPO B
DETALHE PRATELEIRA PT10
FRALDÁRIO

REV. 05

13/16

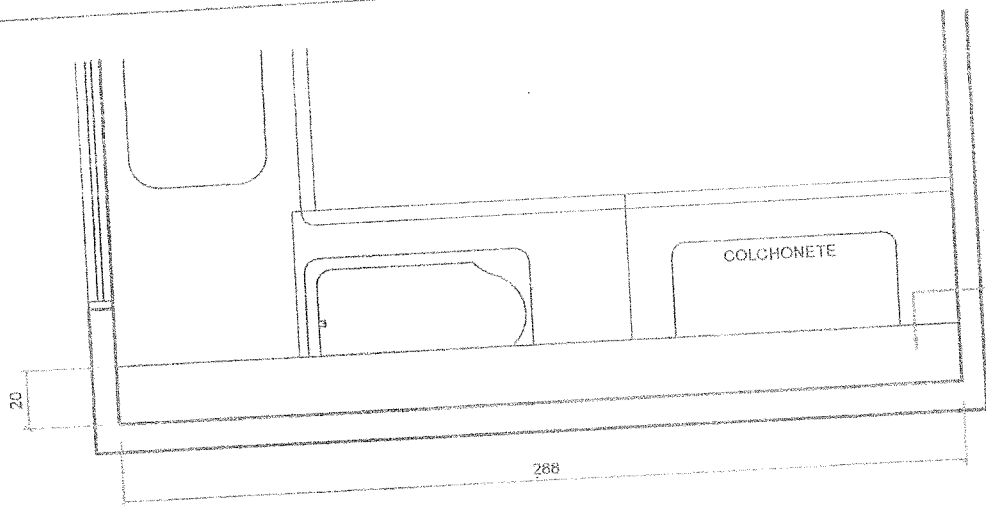

PRATELEIRA PT11
MDF BRANCO 25mm

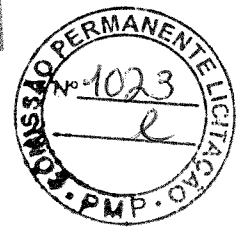

01 PLANTA
ESCALA 1:25

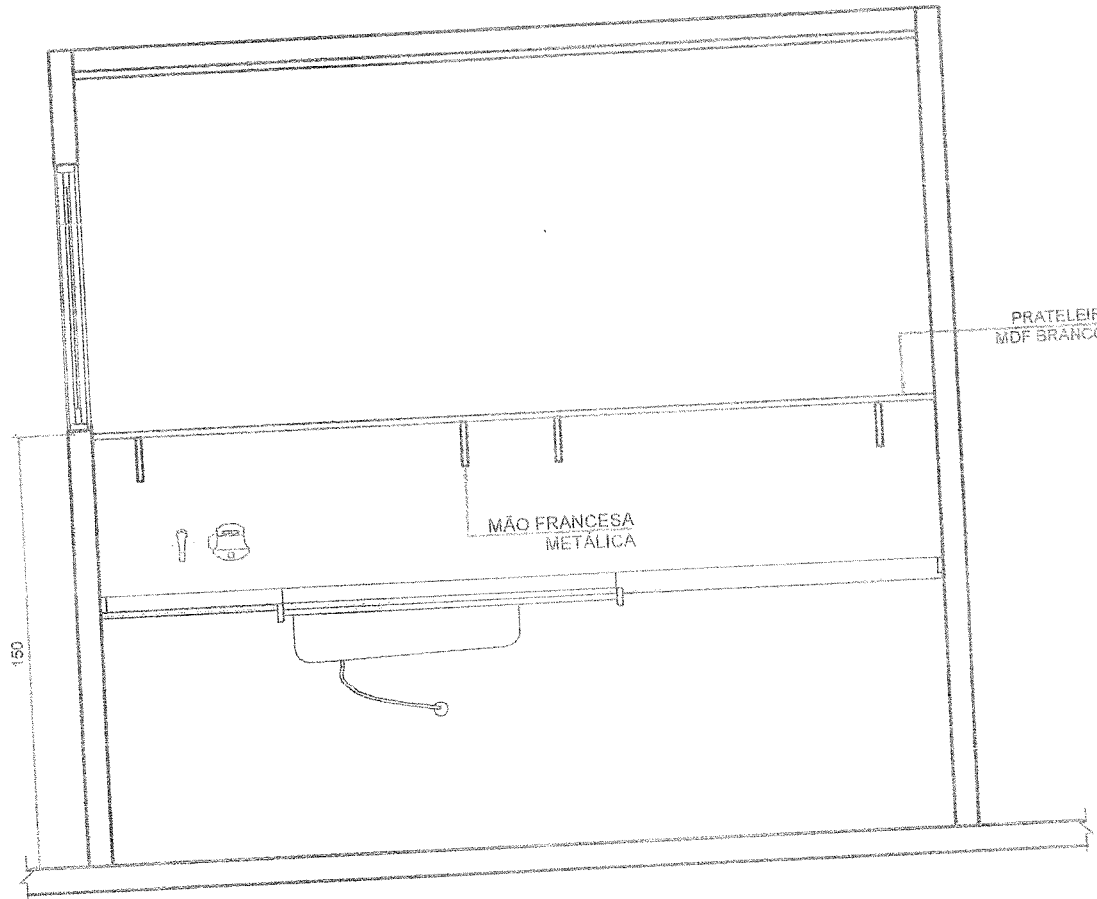

PRATELEIRA PT11
MDF BRANCO 25mm

02 ELEVACÃO
ESCALA 1:25

PLANTA SITUAÇÃO

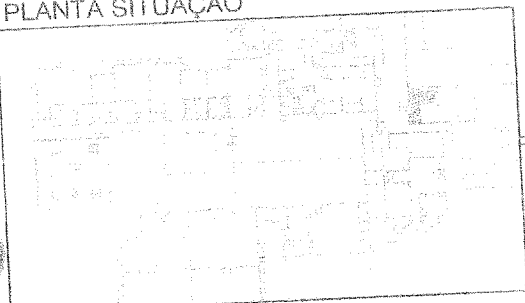

CRECHE TIPO B
DETALHE PRATELEIRA PT11
FRALDÁRIO

REV 05
14/16



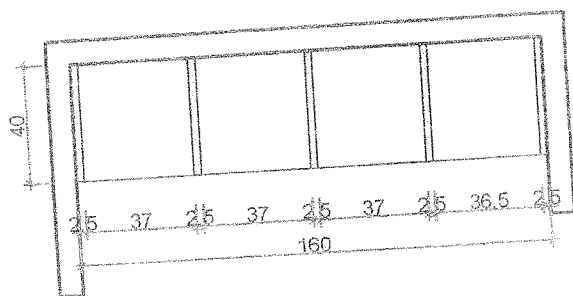
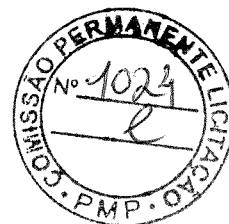
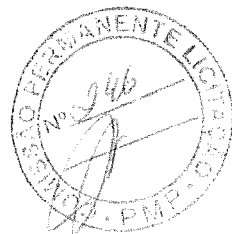

01 PLANTA
ESCALA 1:25

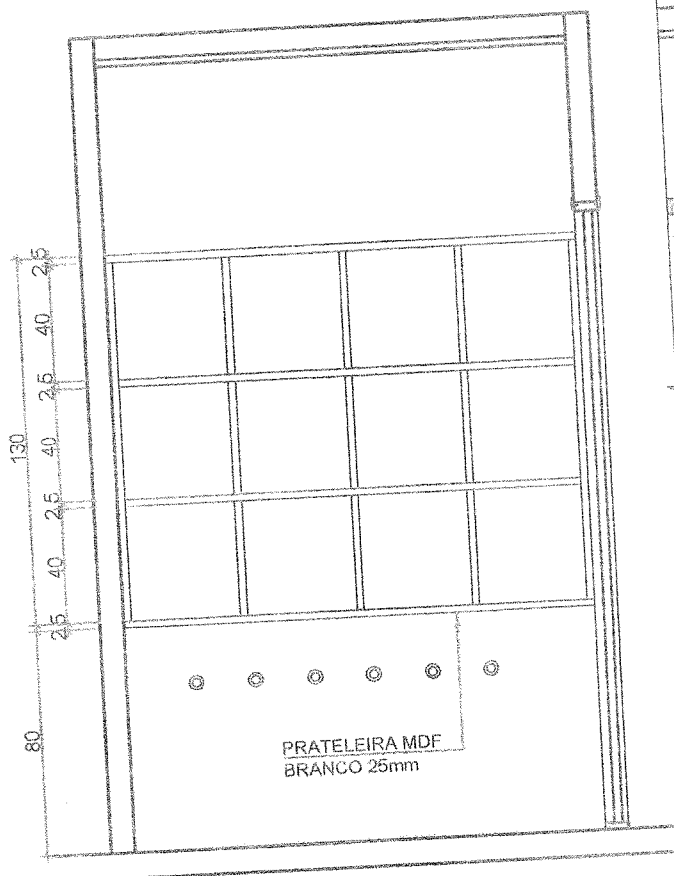

02 ELEVÇÃO
ESCALA 1:25

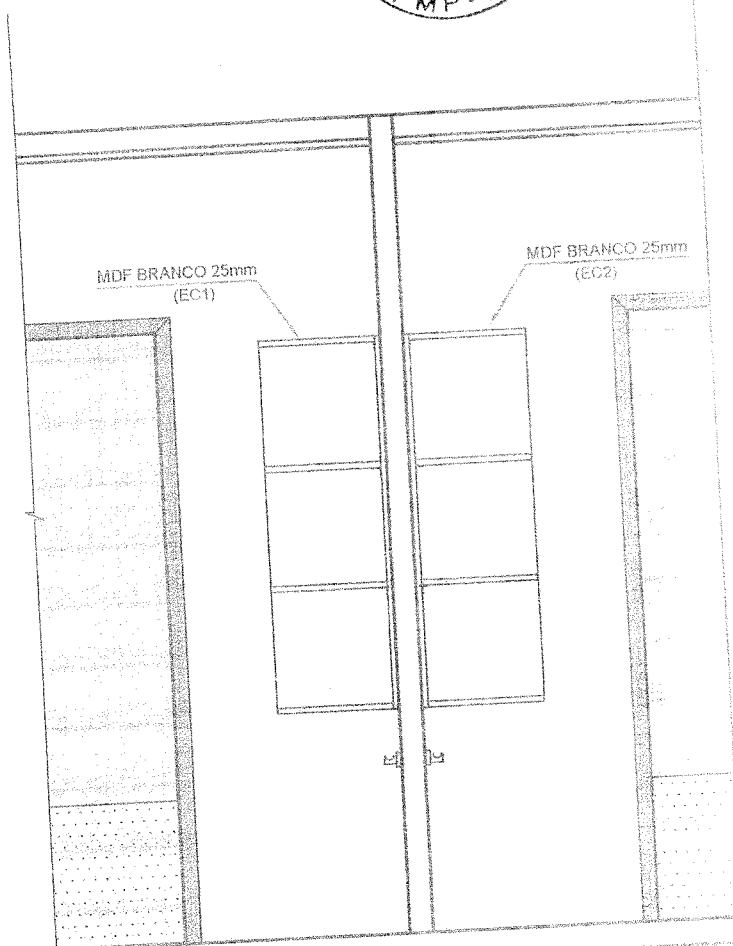

03 CORTE
ESCALA 1:25

PLANTA SITUAÇÃO

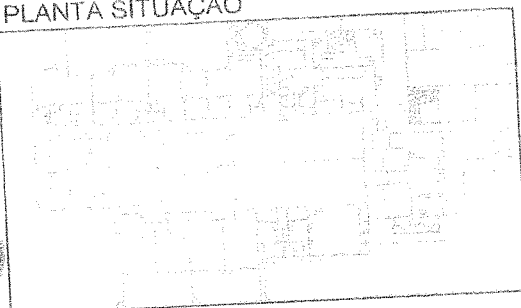

CRECHE TIPO B
DETALHE ESCANINHO EC01/EC02
CRECHES I E II

REV. 05

15/16

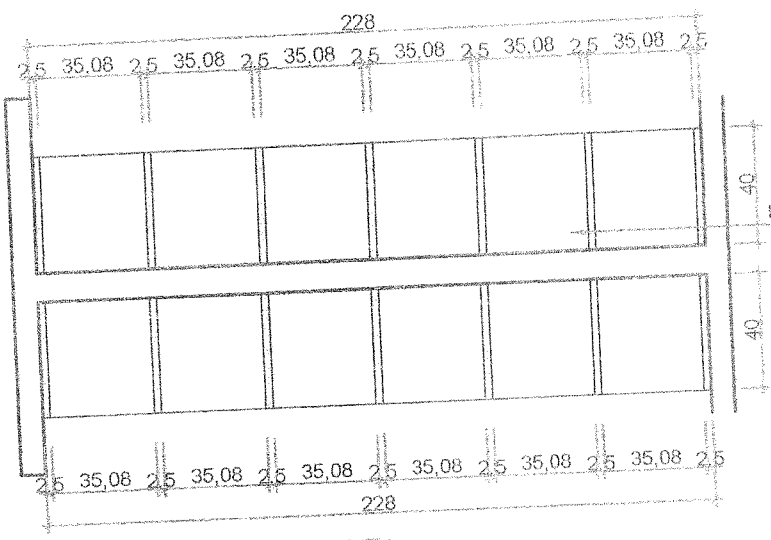
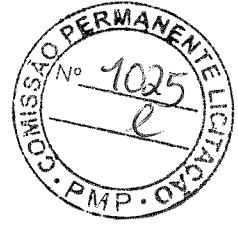

PRATELEIRA EM MDF
BRANCO 25mm

01 PLANTA
ESCALA 1:25

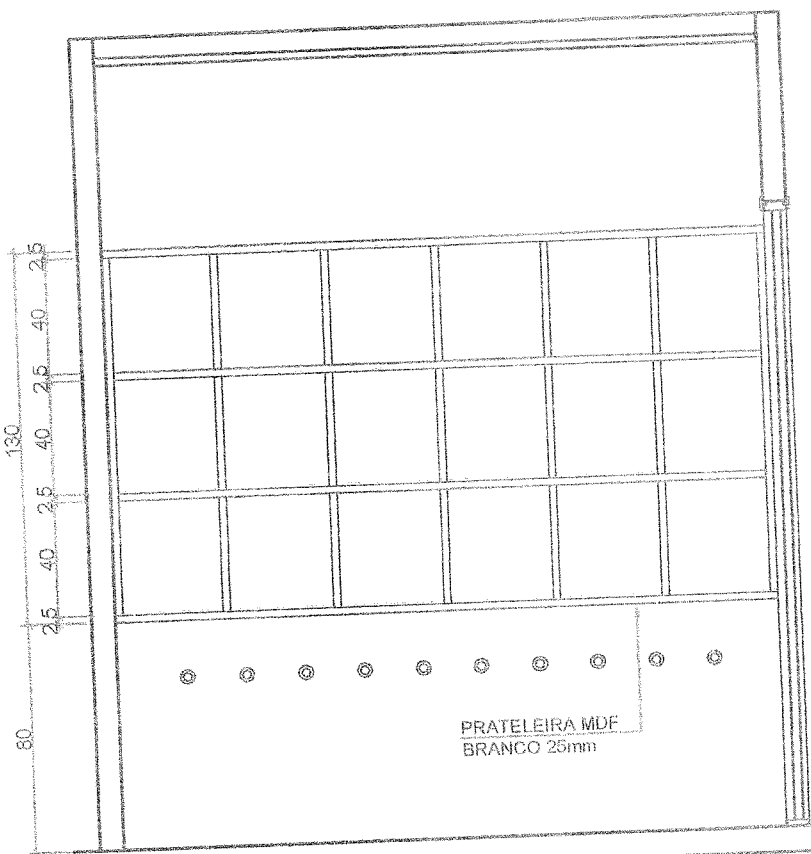

02 ELEVAÇÃO
ESCALA 1:25

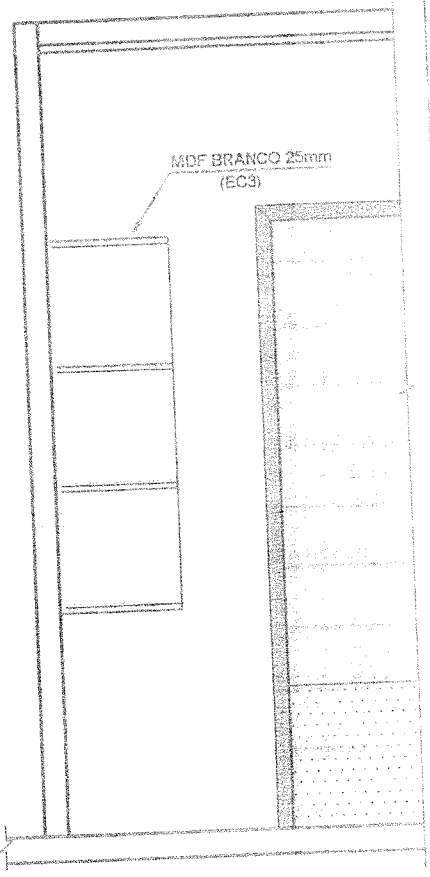

03 CORTE
ESCALA 1:25

PLANTA SITUAÇÃO

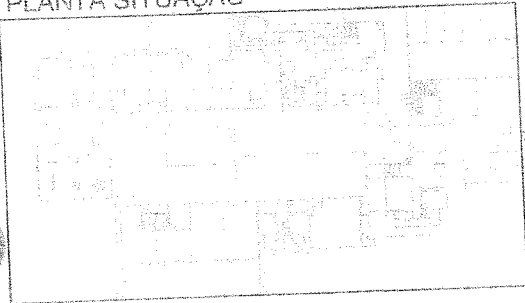

CRECHE TIPO B
DETALHE ESCANINHO EC03
CRECHE III

REV. 06
16/16

DETALHES SERRALHERIA CRECHE TIPO B

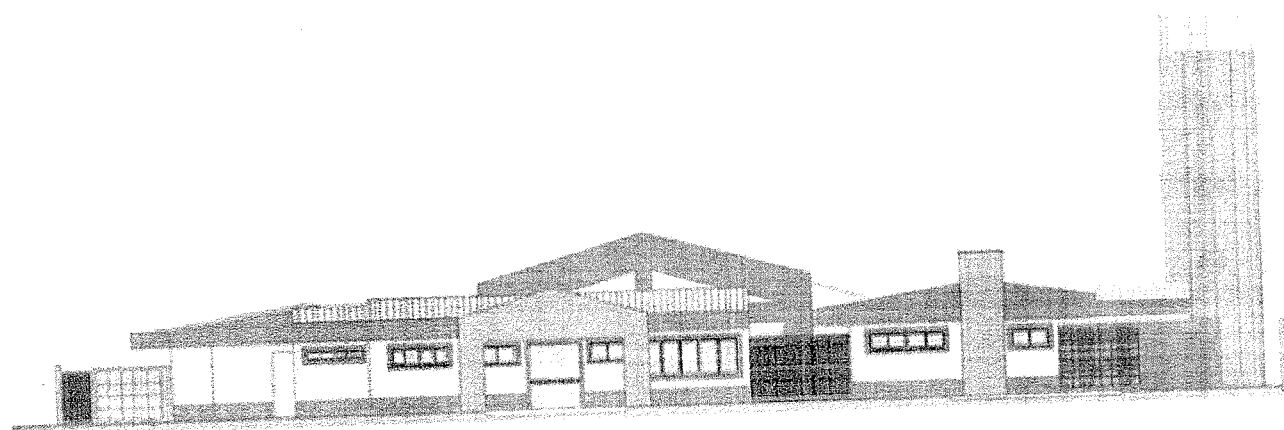
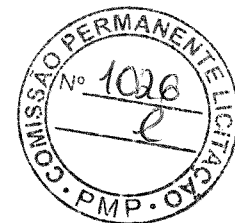
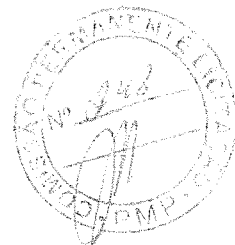

CASALTA
CONSTRUÇÕES

DETALHAMENTO DE SERRALHERIA
PORTÕES, GRADIS E BARRAS

REV. 05

01/17

SERRALHERIA (SER)

(VERIFICAR MEDIDAS NA OBRA)

EMISSÃO: AGOSTO / 2013

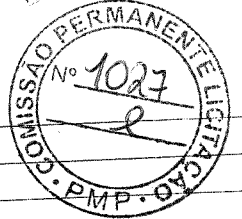
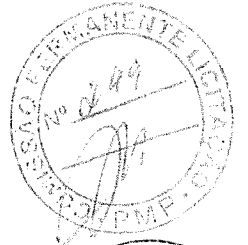

REV.	DATA	FOLHA	DESCRIÇÃO
R00	SETEMBRO/13	-	EMISSÃO INICIAL
R01	13/09/2013	P15	INCLUIDA PRANCHA P15 COM PORTÕES E GRADIL DE VENTILAÇÃO PARA CENTRAL DE GÁS.
R01	02/10/2013	P03	ALTERADA INDICAÇÃO NA TABELA DOS MATERIAIS DE AÇO PARA FERRO
R02	02/10/2013	P04, P05 P06, P07 P08, P09	ALTERADA INDICAÇÃO DOS MATERIAIS DE AÇO PARA FERRO
R03	28/02/2014	---	ALTERADA TODAS AS PRANCHAS DE ACORDO COM A REVISÃO ARQUITETÔNICA
R04	08/10/2014	---	ALTERADA TODAS AS PRANCHAS DE ACORDO COM A REVISÃO ARQUITETÔNICA
R05	17/03/2015	---	ALTERAÇÃO CADERNO DE DETALHES

ÍNDICE DE DETALHES DE SERRALHERIA

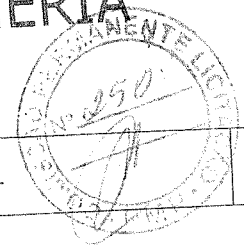
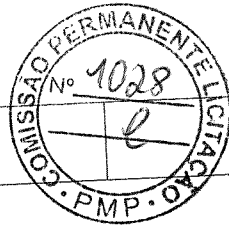

CÓD.	DIMENSÕES (cm) (COMP x LARG)	MATERIAL	TIPO	LOCAL	QTD.
------	---------------------------------	----------	------	-------	------

PORTÕES, GRADIS E BARRAS DE APOIO

GR1	220 x 220cm	FERRO E ARAME GALVANIZADO	GRADIL C/ PORTÃO - PINTURA COR AZUL FRANÇA	ENTRE BLOCO SERVIÇO E BLOCO PEDAGÓGICO 1	01
GR2	160 x 180cm	FERRO E ARAME GALVANIZADO	GRADIL C/ PORTÃO - PINTURA COR AMARELO OURO	ÁREA DE SERVIÇO	01
GR3	321 x 220cm	FERRO E ARAME GALVANIZADO	GRADIL FIXO - PINTURA COR AZUL FRANÇA	ENTRE BLOCO SERVIÇO E BLOCO ADMINISTRATIVO	01
	150 x 220cm	FERRO E ARAME GALVANIZADO	GRADIL C/ PORTÃO - PINTURA COR AZUL FRANÇA	ENTRE BLOCO SERVIÇO E BLOCO ADMINISTRATIVO	01
GR4	226 x 220cm	FERRO E ARAME GALVANIZADO	GRADIL C/ PORTÃO - PINTURA COR AZUL FRANÇA	ENTRE BLOCO ADMINISTRATIVO E BLOCO MULTIUSO	01
GR5	498 x 180cm	FERRO E ARAME GALVANIZADO	GRADIL C/ PORTÃO - PINTURA COR AMARELO	SOLARIUM PRÉ-ESCOLA	01
GR6	520 x 180cm	FERRO E ARAME GALVANIZADO	GRADIL C/ PORTÃO - PINTURA COR AMARELO	SOLARIUM CRECHE I	01
GR7	498 x 100cm	FERRO E ARAME GALVANIZADO	GRADIL C/ PORTÃO - PINTURA COR AMARELO	SOLARIUM CRECHE III	02
GR8	520 x 100cm	FERRO E ARAME GALVANIZADO	GRADIL C/ PORTÃO - PINTURA COR AMARELO	SOLARIUM CRECHE II	02
GR9	308 x 180cm	FERRO E ARAME GALVANIZADO	GRADIL - PINTURA VERMELHO	ÁREA DE SERVIÇO	01
GR10	1469 x 140cm	FERRO GALVANIZADO	FIXA - PINTURA CONFORME DETALHE	MURO FRONTAL	01
GR11	60 x 140cm	FERRO GALVANIZADO	FIXA - PINTURA CONFORME DETALHE	MURO FRONTAL	03
GR12	8,57 x 140cm	FERRO GALVANIZADO	FIXA - PINTURA CONFORME DETALHE	MURO FRONTAL	01
GR13	6,34 x 140cm	FERRO GALVANIZADO	FIXA - PINTURA CONFORME DETALHE	MURO FRONTAL	01
BR1	307 cm	METÁLICO RESIST. A CORROSÃO	C/ ADERÊNCIA E PINTURA AZUL FRANÇA	CRECHES I, II, III E PRÉ ESCOLA	08
BR2	367cm	METÁLICO RESIST. A CORROSÃO	C/ ADERÊNCIA E PINTURA AZUL FRANÇA	SALA MULTIUSO	01
PT1	160 x 215cm	FERRO GALVANIZADO	2 FOL. DE GIRO - PINTURA CONFORME DETALHE	ACESSO PEDESTRES	02
PT2	330 x 215cm	FERRO GALVANIZADO	1 FOLHA DE CORRER - PINTURA CONFORME DETALHE	ACESSO VEÍCULOS	01

OBSERVAÇÕES

- * CONFIRMAR DIMENSÕES NA OBRA.
- * TODOS OS DETALHES FORAM REPRESENTADOS NA ESCALA 1/25, EXCETO QUANDO INDICADA.

CRECHE TIPO B

CONTROLE DE ALTERAÇÃO DE
DETALHES DE SERRALHERIA

REV. 05

03/17



CASALTA
CONSTRUÇÕES

PLANTA SITUAÇÃO

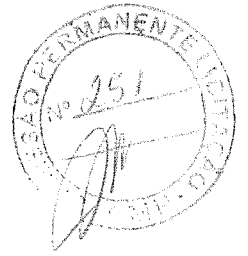
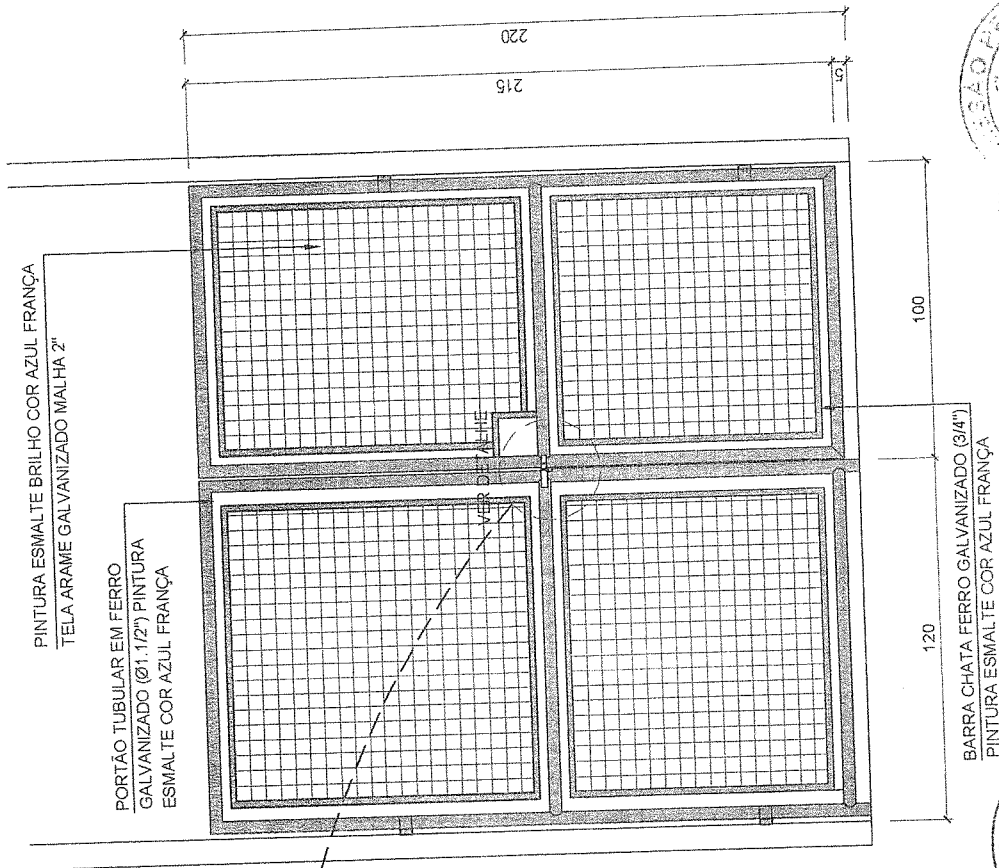
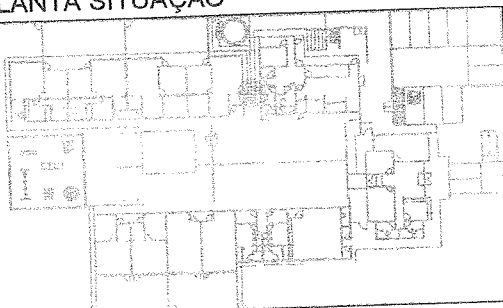

ELEVAÇÃO
ESCALA 1:25

03

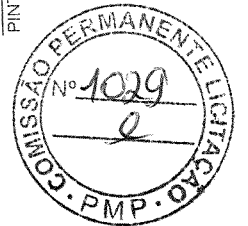

PLANTA
ESCALA 1:25

02

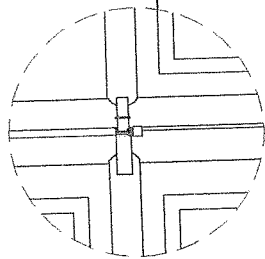

DETALHE TRAVA
COM PORTA CADEADO
ESCALA 1:10

01

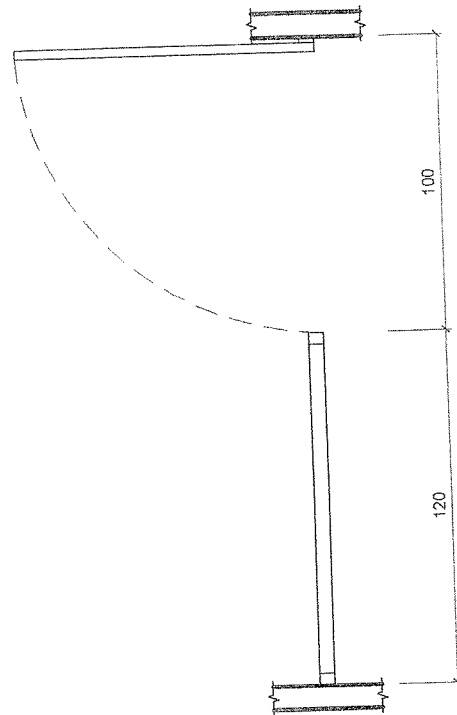

CRECHE TIPO B
DETALHE GRADIL GR1 - ENTRE
BL. SERVIÇO E PEDAGÓGICO 1

REV. 05

04/17

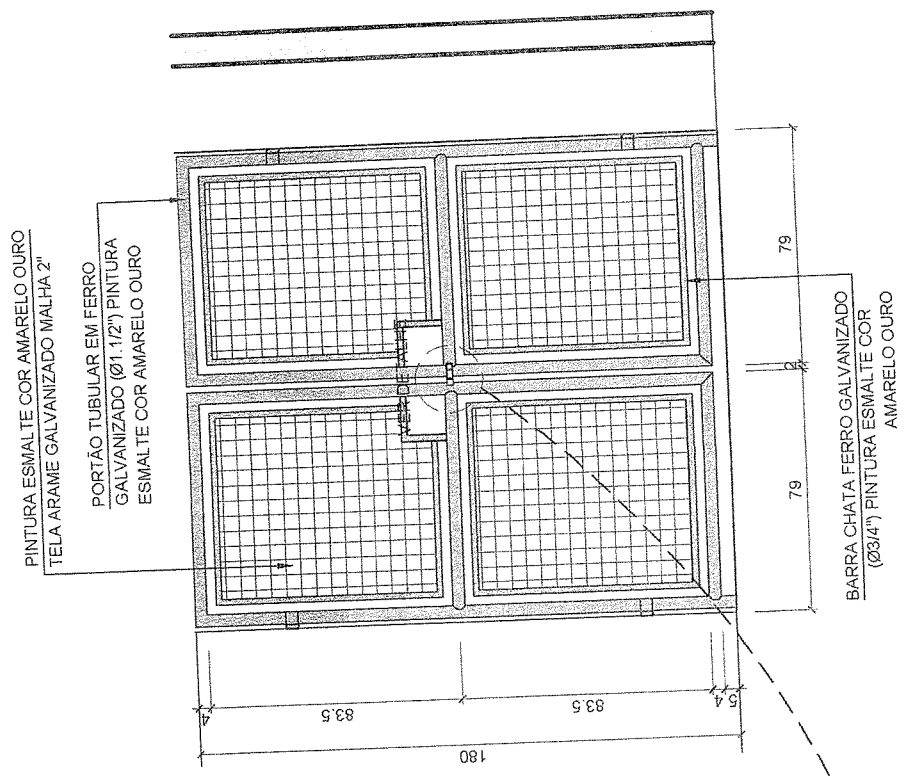
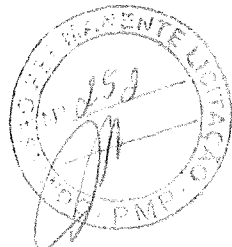

ELEVACÃO
ESCALA 1:25
03

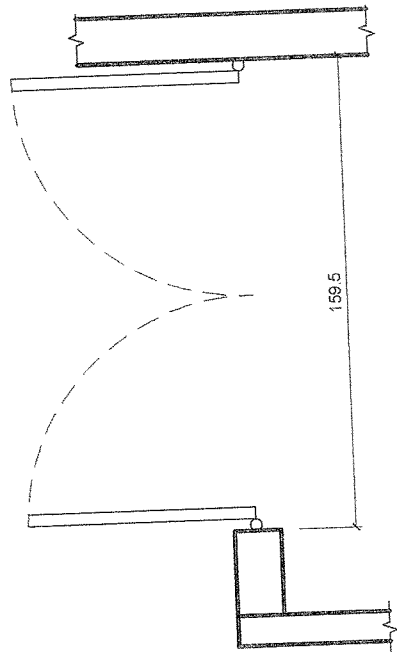
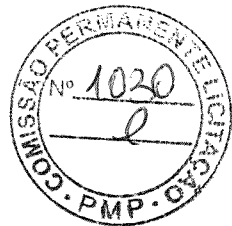

PLANTA
ESCALA 1:25
01

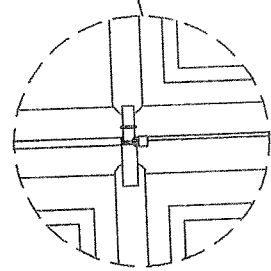

DETALHE TRAVA
COM PORTA CADEADO
ESCALA 1:10
02

PLANTA SITUAÇÃO

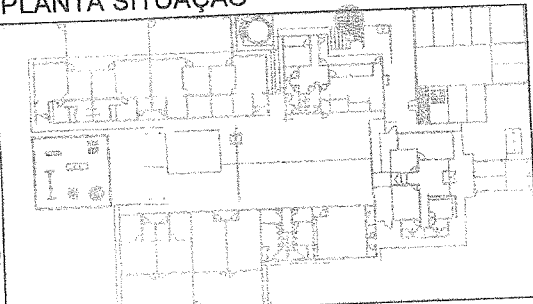

CRECHE TIPO B
DETALHE GRADIL GR2
ÁREA DE SERVIÇO

REV. 05
05/17



BARRA CHATA FERRO GALVANIZADO
(Ø1.1/2") PINTURA ESMALTE AZUL FRANÇA

PINTURA ESMALTE BRILHO COR AZUL FRANÇA
TELA ARAME GALVANIZADO MALHA 2"

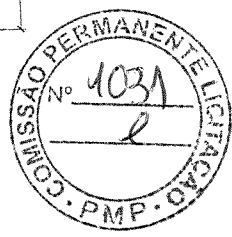
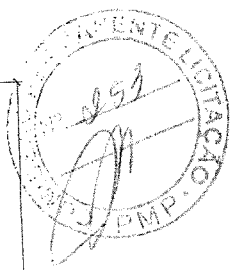
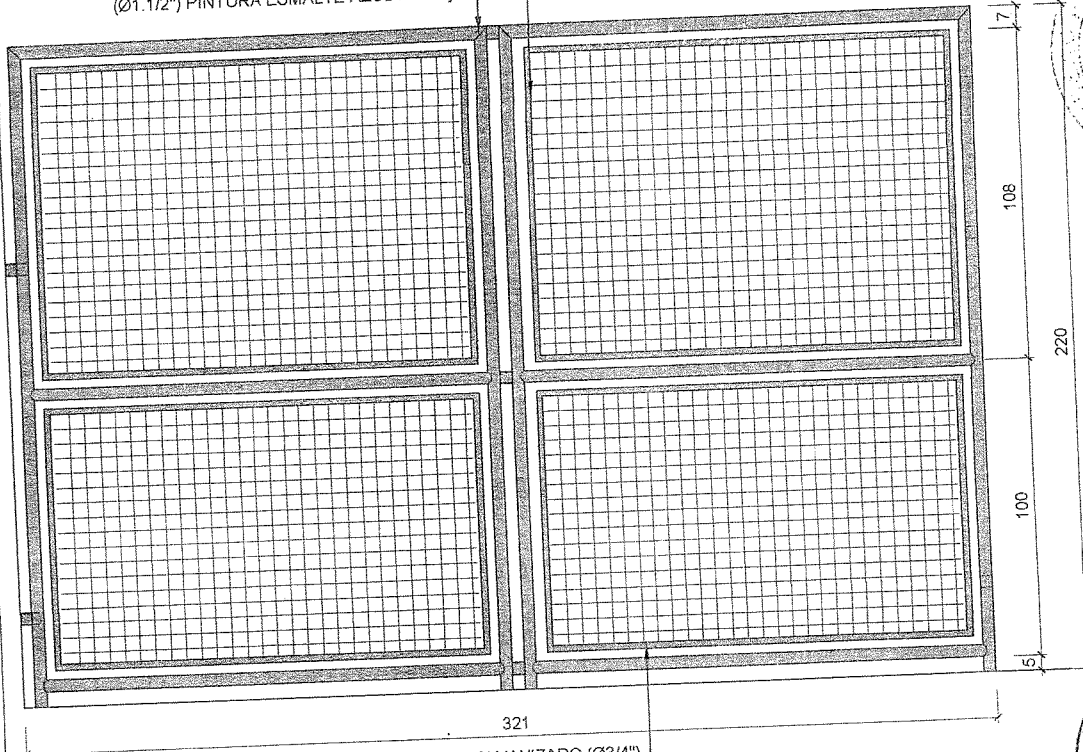

BARRA CHATA FERRO GALVANIZADO (Ø3/4")
PINTURA ESMALTE COR AZUL FRANÇA

BARRA CHATA FERRO GALVANIZADO
(Ø1.1/2") PINTURA ESMALTE AZUL FRANÇA

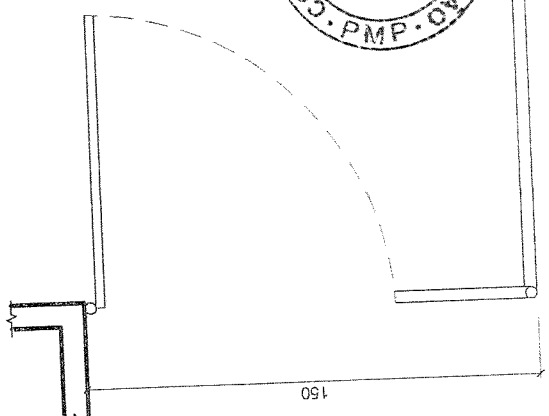
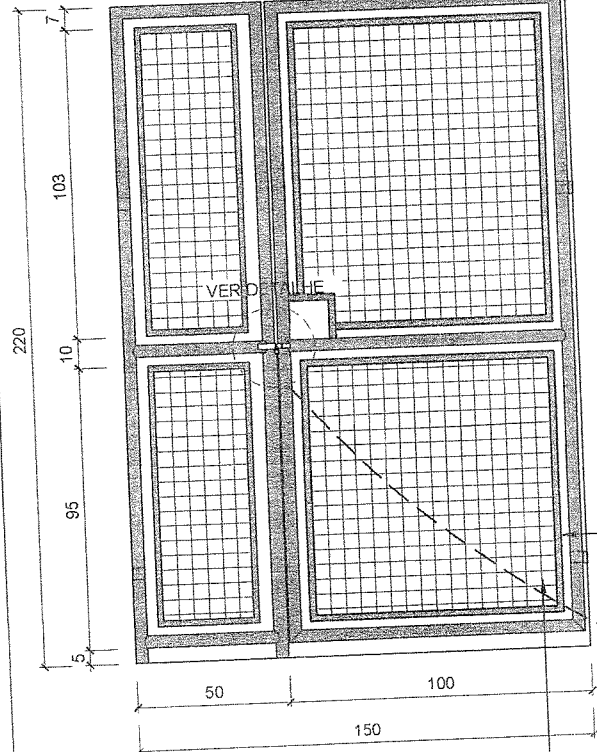

PLANTA
ESCALA 1:25

BARRA CHATA FERRO GALVANIZADO
(Ø3/4") PINTURA ESMALTE AZUL FRANÇA

TELA ARAME GALVANIZADO
MALHA 2", PINTURA ESMALTE
COR AZUL FRANÇA

ELEVAÇÕES
ESCALA 1:25

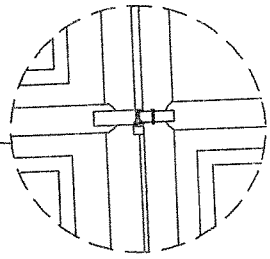

DETALHE TRAVA
COM PORTA CADEADO
ESCALA 1:10

PLANTA SITUAÇÃO

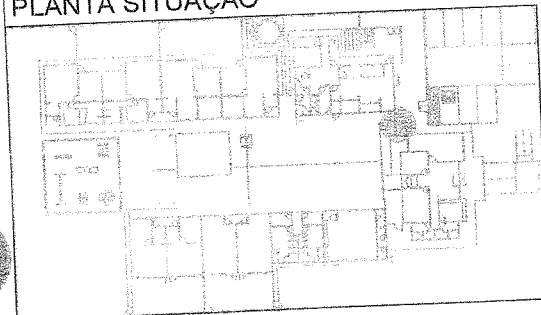

CRECHE TIPO B
DETALHE GRADIL GR3
ENTRE BL. SERVIÇO E ADMINISTR.

REV. 05

06/17



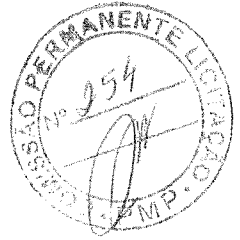

TELA ARAME GALVANIZADO
MALHA 2" PINTURA ESMALTE
COR AZUL-FRANÇA

ELEVÇÃO
ESCALA 1:25

03

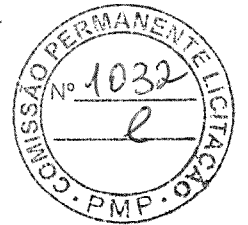

BARRA CHATA FERRO GALVANIZADO
(Ø3/4") PINTURA ESMALTE COR AZUL-FRANÇA

126

100

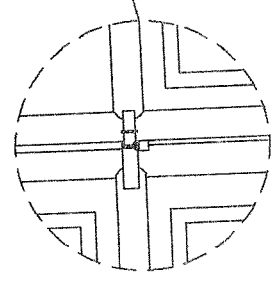

DETALHE TRAVA
COM PORTA CADEADO
ESCALA 1:10

02

PLANTA
ESCALA 1:25

01

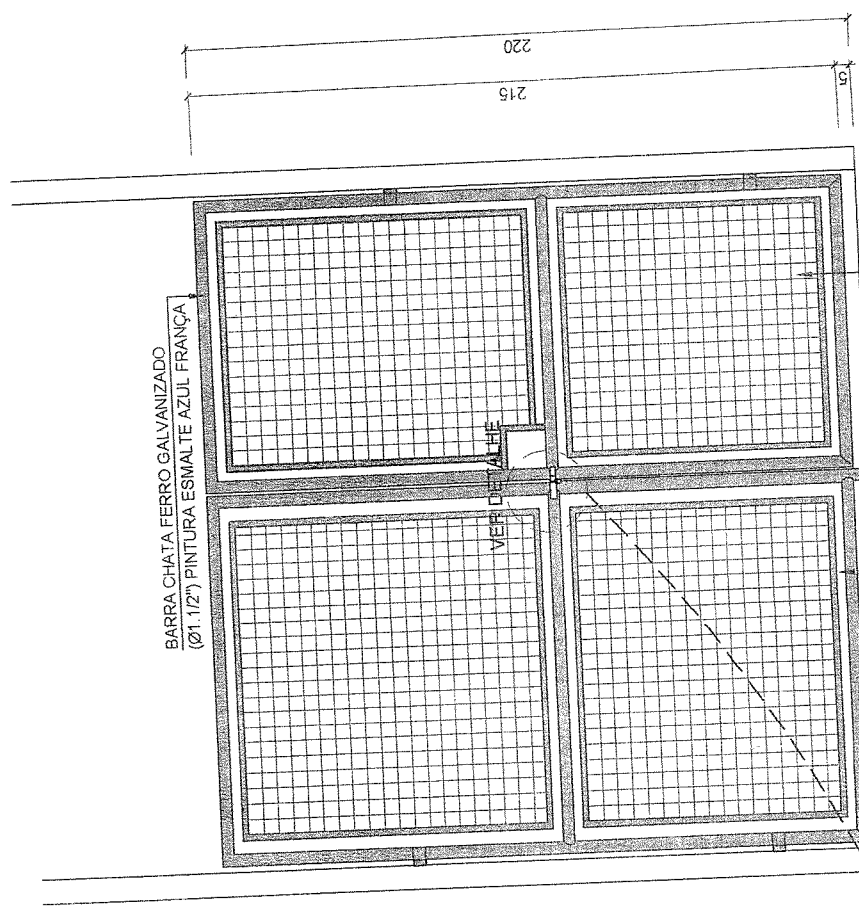
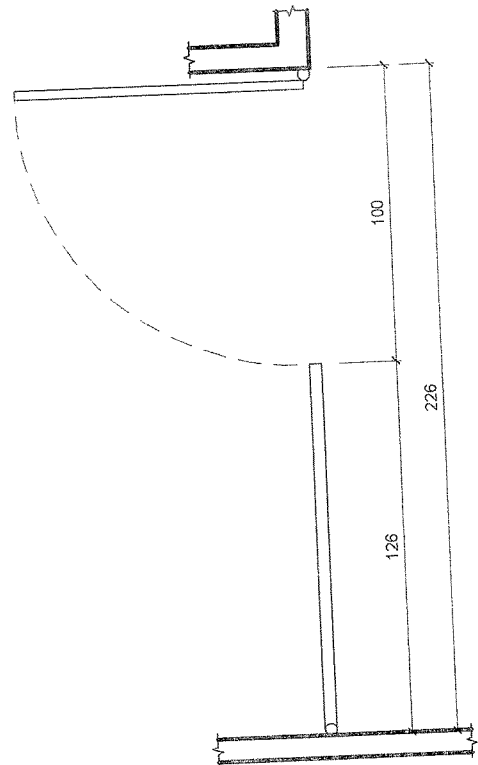

BARRA CHATA FERRO GALVANIZADO
(Ø1.1/2") PINTURA ESMALTE AZUL-FRANÇA

VER DETALHE

PLANTA SITUAÇÃO

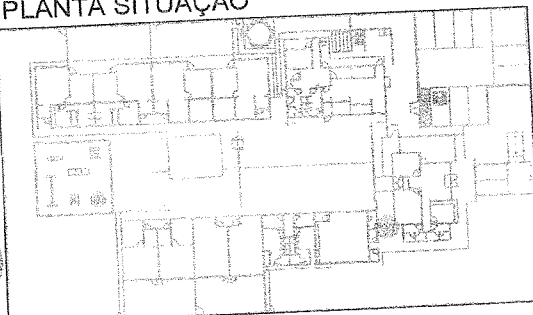

CRECHE TIPO B
DETALHE GRADIL GR4
ENTRE BL. ADM. E MULTIUSO

REV. 05

07/11

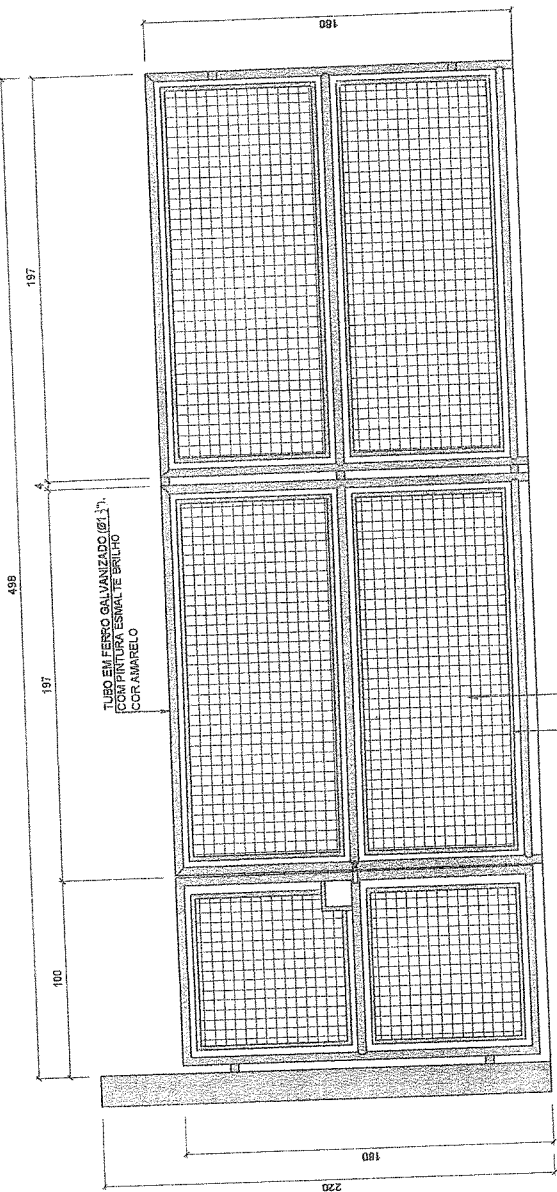

TUBO EM FERRO GALVANIZADO Ø 1,7"
COM PINTURA ESMALTE BRILHO
COR AMARELO

TELA DE ARAME GALVANIZADO
EM MALHA QUADRANGULAR 2"
COM PINTURA ESMALTE BRILHO
COR AMARELO

BARRA CHATA EM FERRO GALVANIZADO 1,7"
COM PINTURA ESMALTE BRILHO
COR AMARELO

01 ELEVÇÃO GR5
ESCALA 1:25

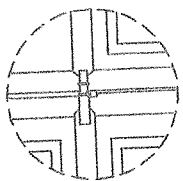

03 DETALHE TRAVA
COM PORTA CADEADO
ESCALA 1:10

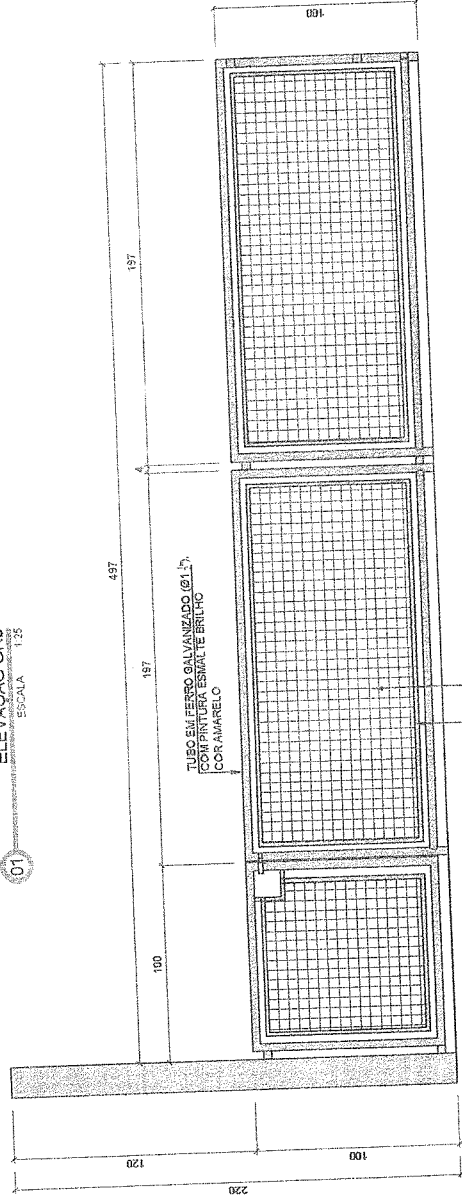

TUBO EM FERRO GALVANIZADO Ø 1,7"
COM PINTURA ESMALTE BRILHO
COR AMARELO

TELA DE ARAME GALVANIZADO
EM MALHA QUADRANGULAR 2"
COM PINTURA ESMALTE BRILHO
COR AMARELO

BARRA CHATA EM FERRO GALVANIZADO 1,7"
COM PINTURA ESMALTE BRILHO
COR AMARELO

02 ELEVÇÃO GR7
ESCALA 1:25

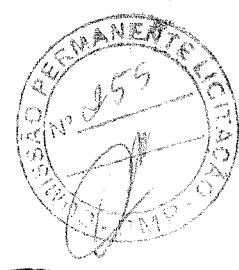
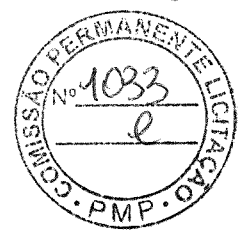

PLANTA SITUAÇÃO

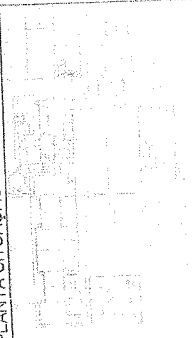

REV. 06

CRECHE TIPO B

0817

DETALHE GRADIS GR5 E GR7
SOLARIUM PRÉ ESCOLA

CASALTA
CONSTRUÇÕES

301CRB-DET-PE-003-SER-GER-R05.BV4

TUBO EM FERRO GALVANIZADO (Ø1.5"),
COM PINTURA ESMALTADA BRILHO,
COR AMARELO

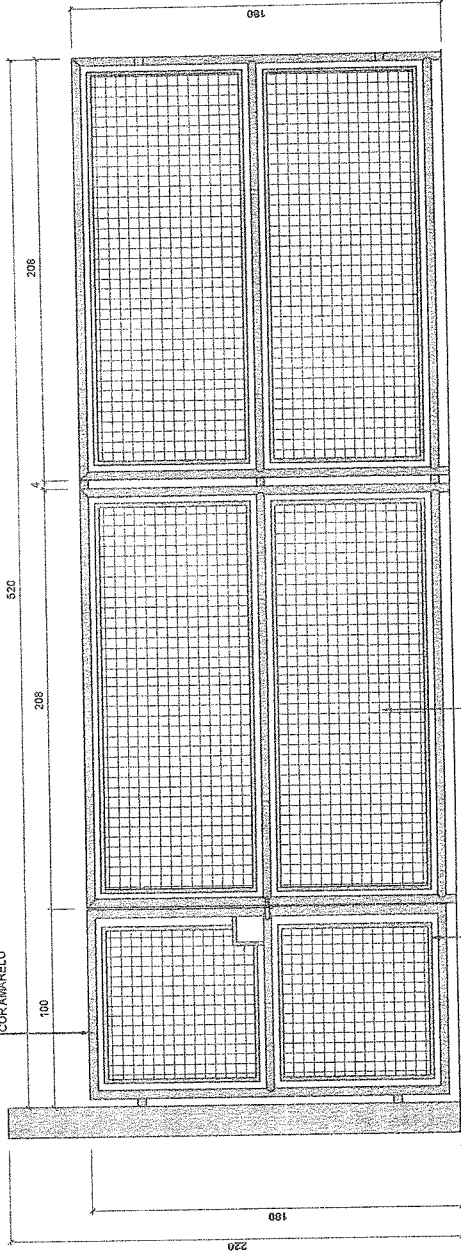

BARRA CHATA EM FERRO GALVANIZADO (1.5"),
COM PINTURA ESMALTADA BRILHO,
COR AMARELO

TELA DE ARAME GALVANIZADO,
EM MALHA QUADRANGULAR 2",
COM PINTURA ESMALTADA BRILHO,
COR AMARELO

01 ELEVÇÃO GR6
ESCALA 1:25

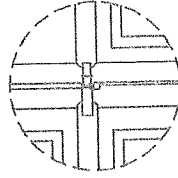

03 DETALHE TRAVA
COM PORTA CADEADO
ESCALA 1:10

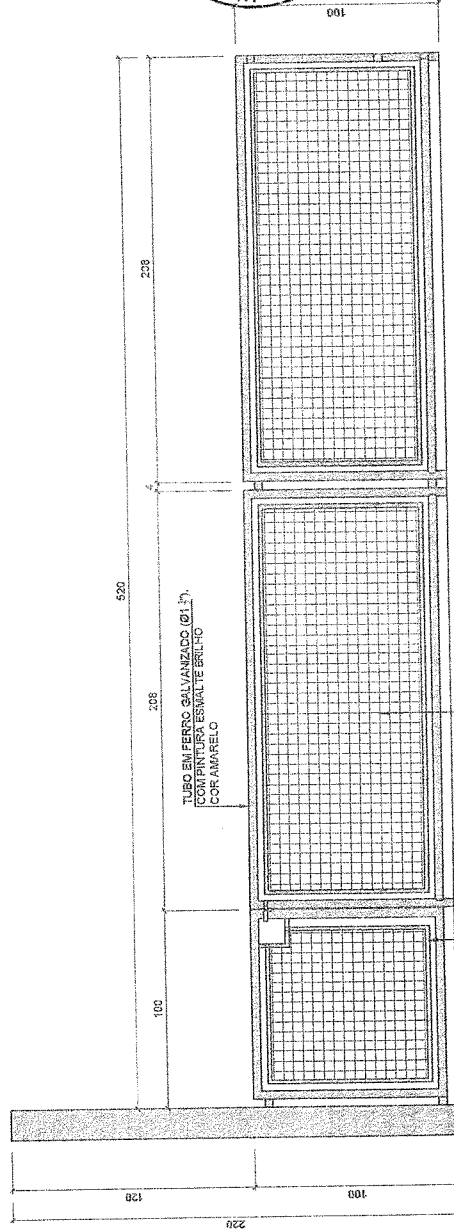

BARRA CHATA EM FERRO GALVANIZADO (1.5"),
COM PINTURA ESMALTADA BRILHO,
COR AMARELO

TELA DE ARAME GALVANIZADO,
EM MALHA QUADRANGULAR 2",
COM PINTURA ESMALTADA BRILHO,
COR AMARELO

TUBO EM FERRO GALVANIZADO (Ø1.5"),
COM PINTURA ESMALTADA BRILHO,
COR AMARELO

02 ELEVÇÃO GR8
ESCALA 1:25

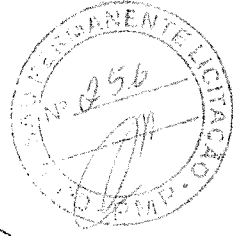
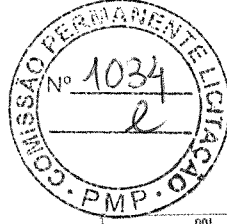

PLANTA SITUÇÃO

CASALTY
CONSTRUÇÕES

CRECHE TIPO B
DETALHE GRADIS GR6 E GR8
SOLARIUM CRECHE I E CRECHE II

REV. 06

09/17

301CR8-DET-PE-003-SER-0-EP-RC6-002

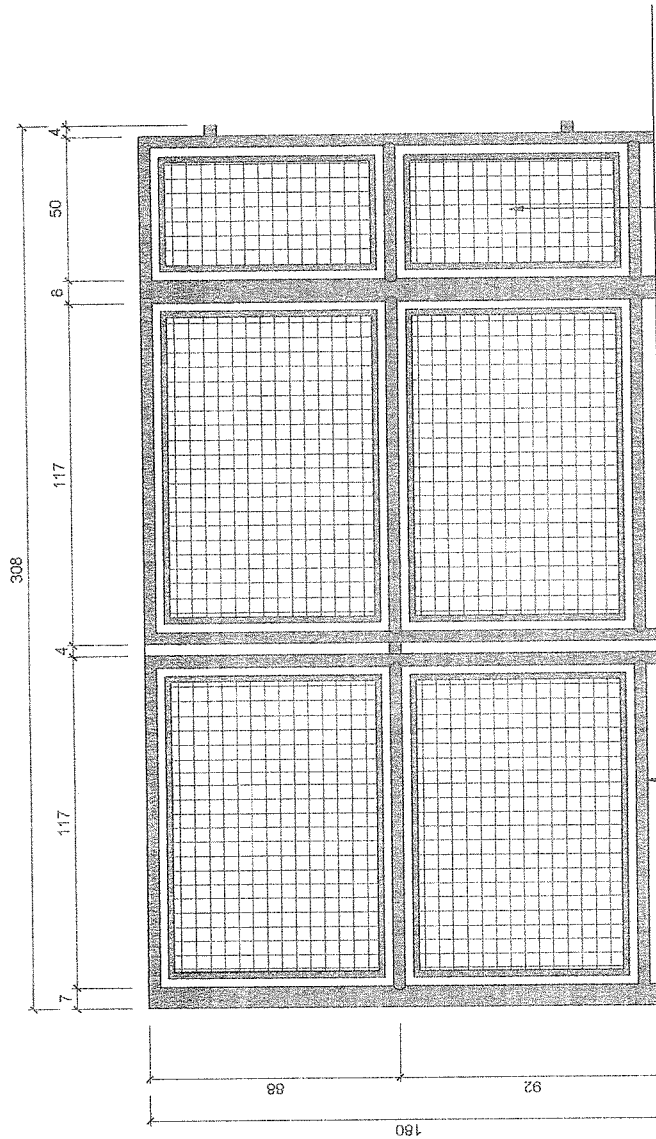
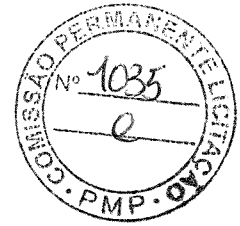
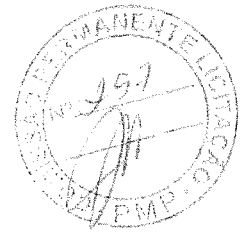

TELA DE ARAME GALVANIZADO, EM MALHA QUADRANGULAR 2",
COM PINTURA ESMALTE BRILHO COR AMARELO

BARRA CHATA EM FERRO GALVANIZADO (2"),
COM PINTURA ESMALTE BRILHO,
COR AMARELO

ELEVACÃO
ESCALA 1:25



PLANTA SITUAÇÃO

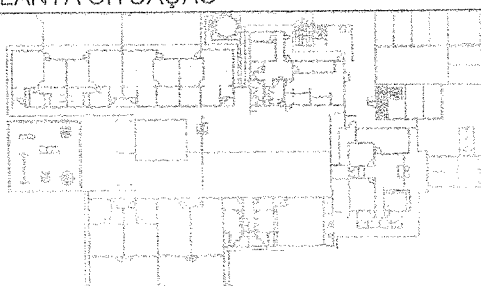

CRECHE TIPO B
DETALHE GRADIL GR9
BLOCO SERVIÇO

REV. 05

10/17



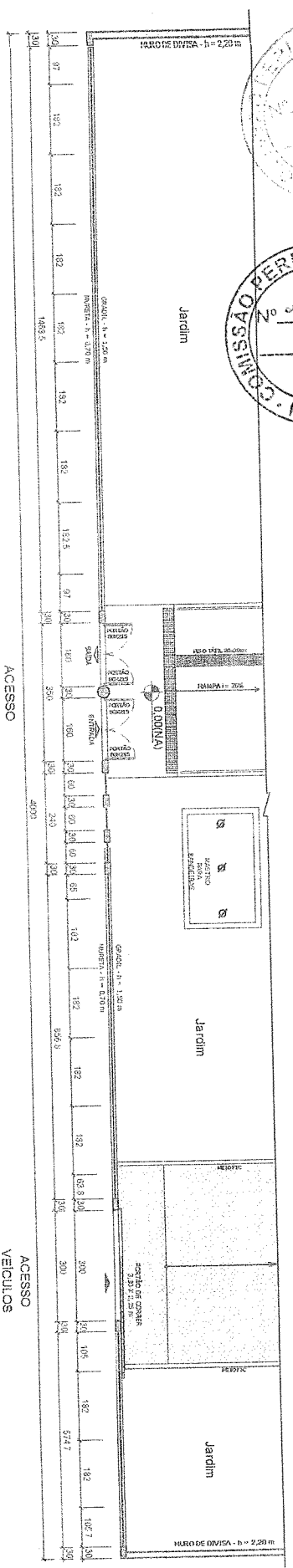
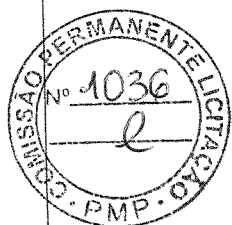
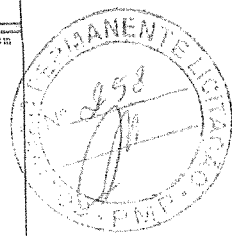

ACESSO PEDESTRES

ACESSO VEICULOS

PLANTA SITUACAO

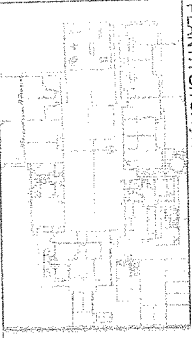

MARCAÇÃO DOS GRADIS ESCALA 1:100

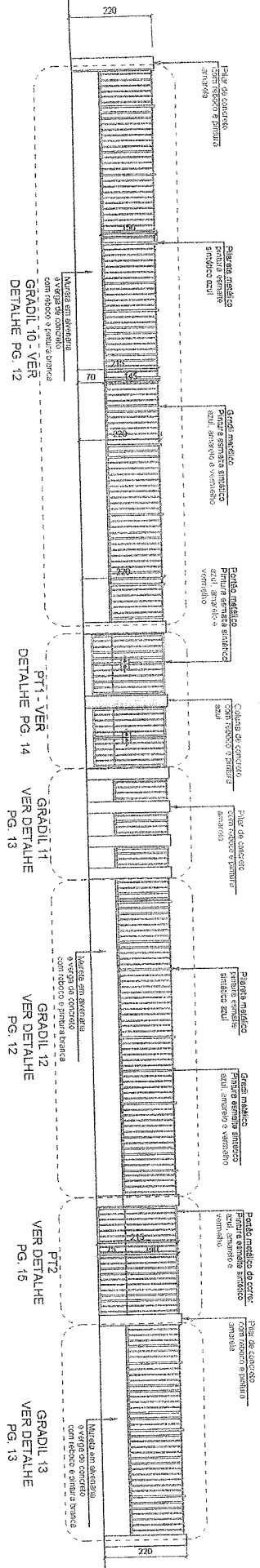

GRADIL 10 - VER DETALHE PG. 12

PT1 - VER DETALHE PG. 14

GRADIL 11 VER DETALHE PG. 13

GRADIL 12 VER DETALHE PG. 12

PT2 VER DETALHE PG. 15

GRADIL 13 VER DETALHE PG. 13

CASALTA CONSTRUÇÕES

CRECHE TIPO B

DETALHE GRADIS MURO

301 CRB-DET-PE-003-GER-GER-R05-ANG

REV. 05
11/17

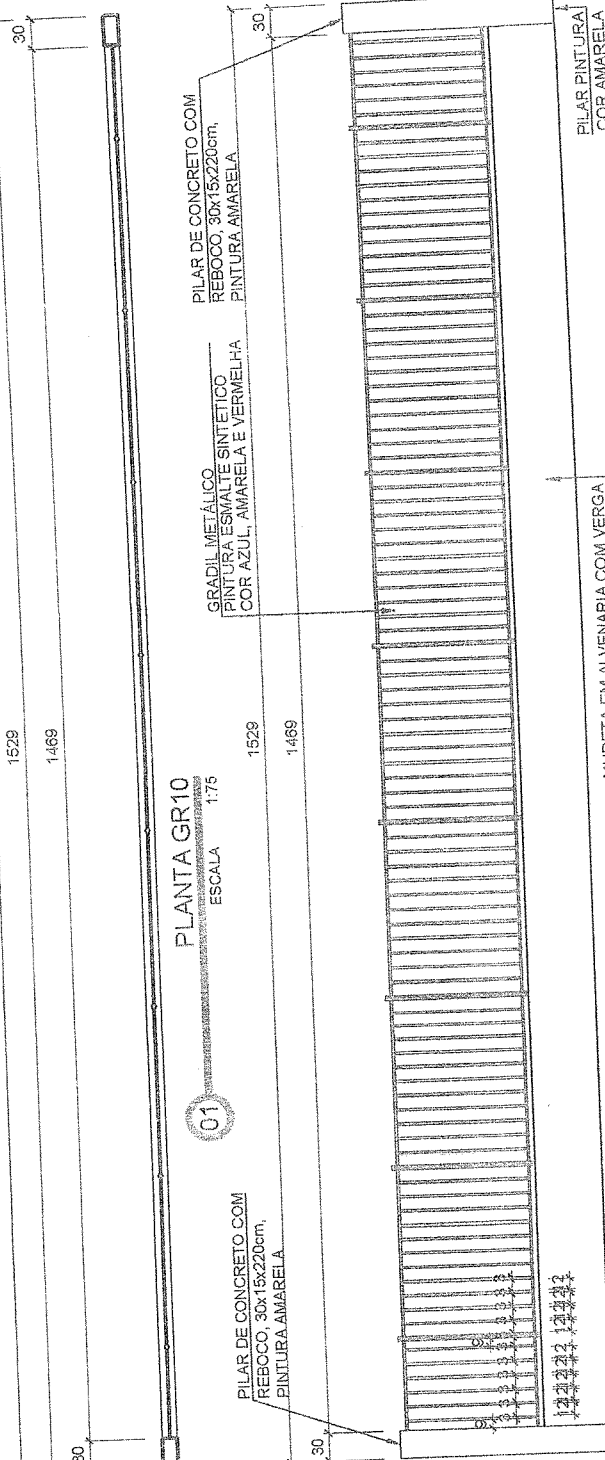
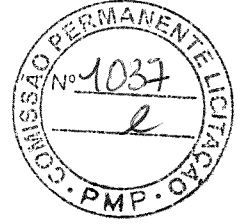

PLANTA GR10
ESCALA 1:75

ELEVÇÃO GR10
ESCALA 1:75

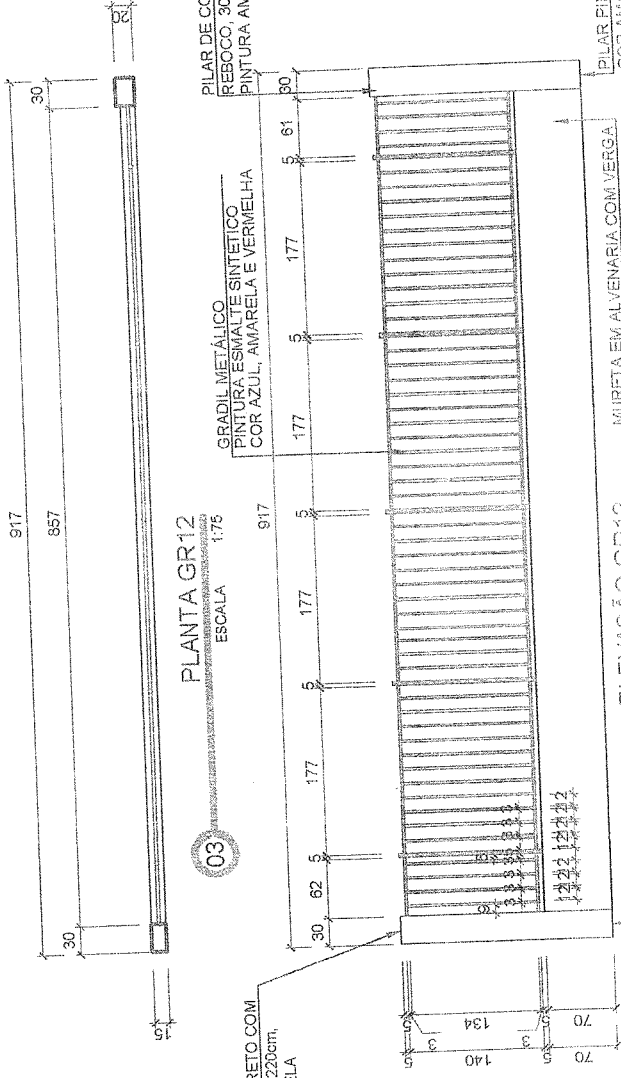

PLANTA GR12
ESCALA 1:75

ELEVÇÃO GR12
ESCALA 1:75

PLANTA SITUAÇÃO

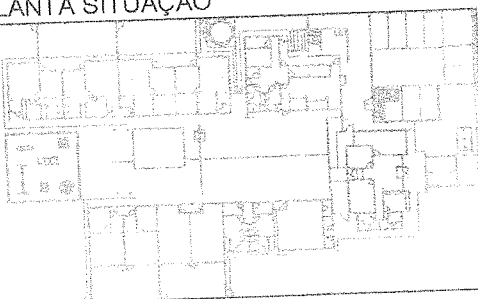

CRECHE TIPO B DETALHE GRADIS GR10 E GR12 MURO FRONTAL

REV. 05

12/17



PLANTA SITUAÇÃO

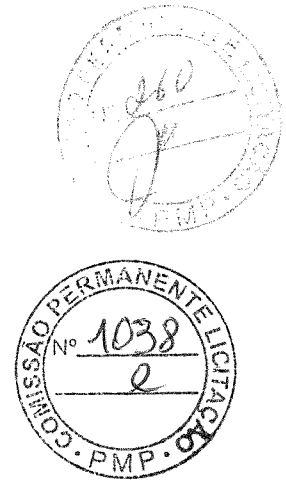
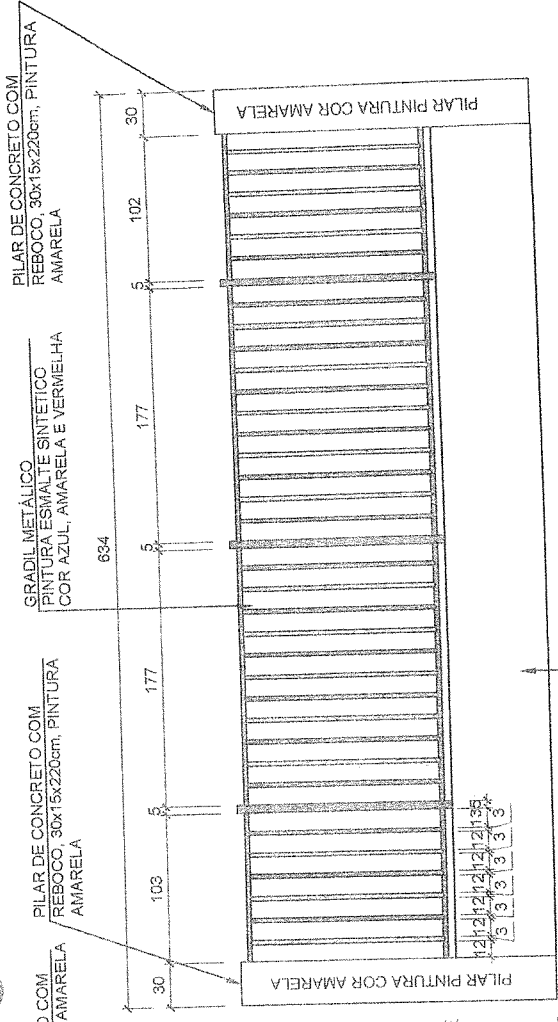
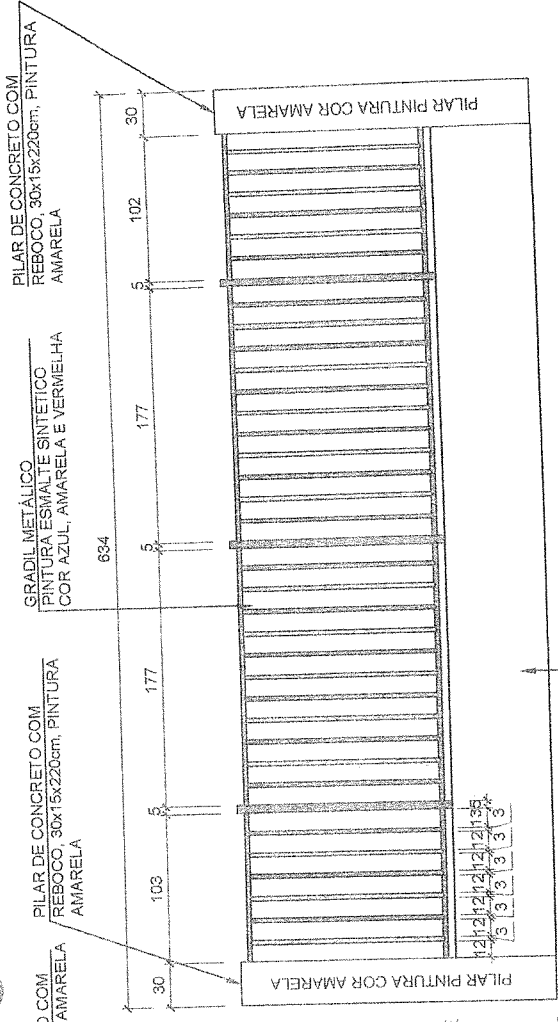
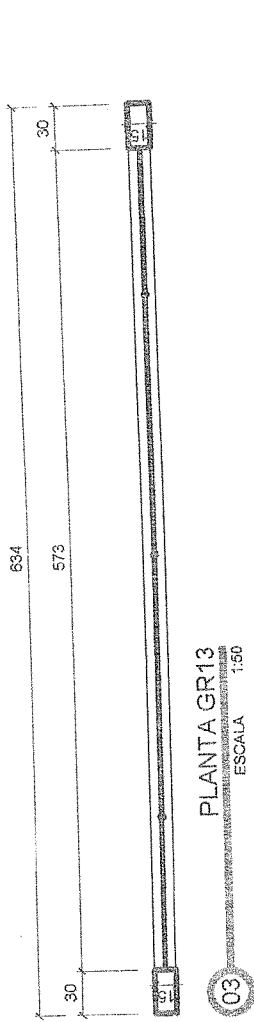
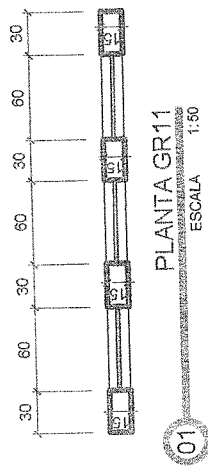
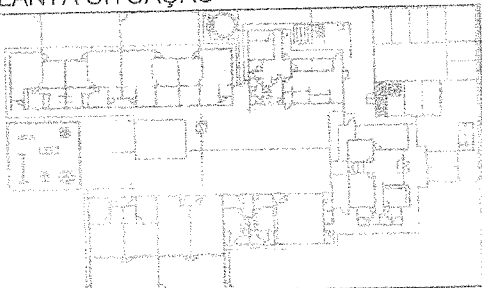

CRECHE TIPO B
DETALHE GRADIS GR11 E GR13
MURO FRONTAL

REV. 05
13/17